

Ultramid® (PA)

Product Brochure

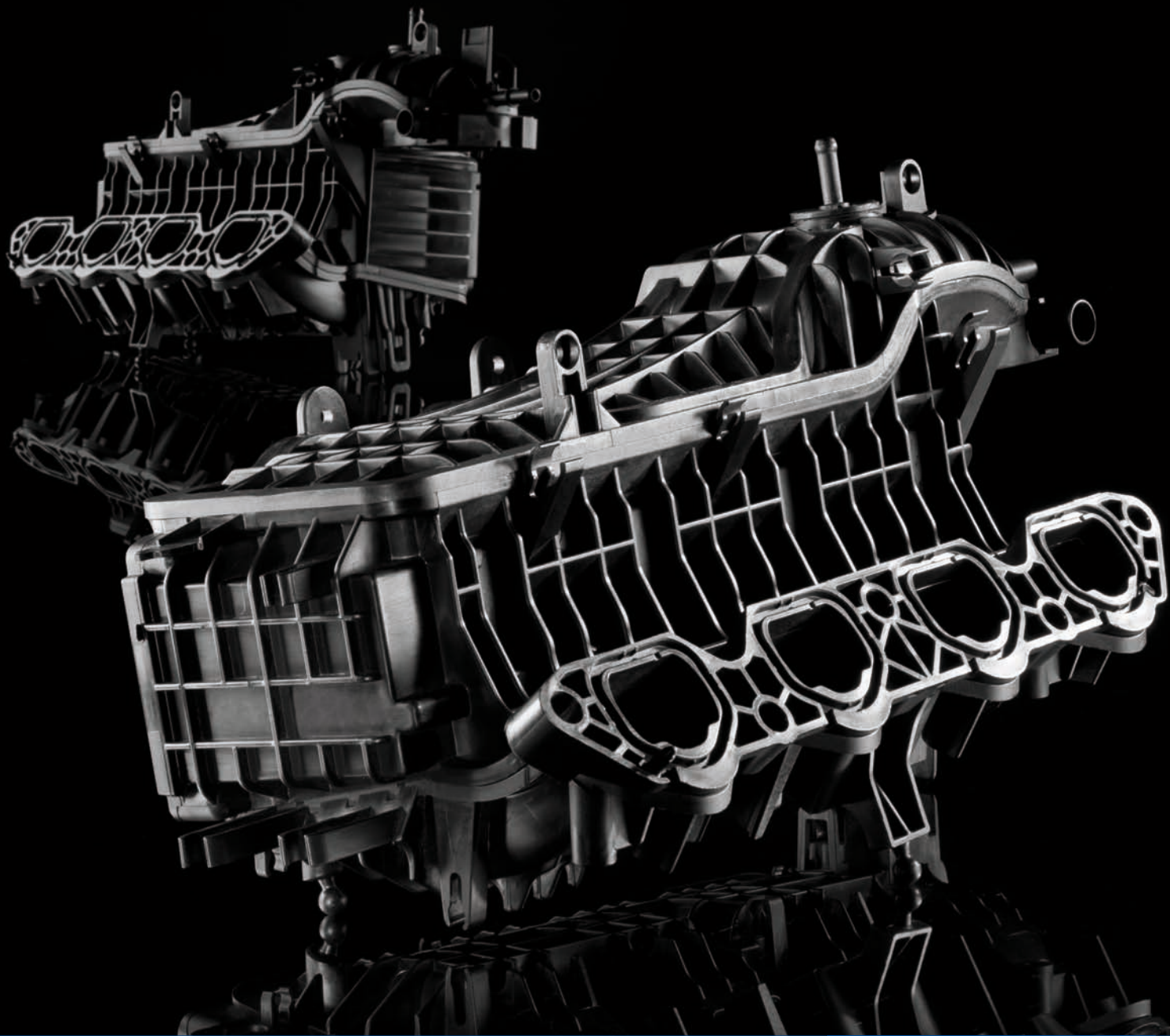

 **BASF**

The Chemical Company

Ultramid® (PA)

BASF's Ultramid® grades are molding compounds on the basis of PA6, PA66 and various co-polyamides such as PA66/6. The range also includes PA610 and partially aromatic polyamides such as PA6T/6. The molding compounds are available unreinforced, reinforced with glass fibers or minerals and also reinforced with long-glass fibers for special applications. Ultramid® is noted for its high mechanical strength, stiffness and thermal stability. In addition, Ultramid® offers good toughness at low temperatures, favorable sliding friction behavior and can be processed without any problems. Owing to its excellent properties, this material has become indispensable in almost all sectors of engineering for a wide range of different components and machine elements, as a high-grade electrical insulation material and for many special applications.

Ultramid® (PA)

ULTRAMID® IN AUTOMOTIVE APPLICATIONS		4-5
ULTRAMID® IN THE ELECTRICAL AND ELECTRONICS SECTOR		6-7
ULTRAMID® FOR INDUSTRIAL PRODUCTS AND CONSUMER GOODS		8-9
THE PROPERTIES OF ULTRAMID®		10-39
	Product range	10
	Mechanical properties	16
	Thermal properties	22
	Water absorption and dimensional stability	24
	Electrical properties	26
	Fire behavior	28
	Resistance to chemicals	30
	Behavior on exposure to weather	36
	Ultramid® T	37
	Ultramid® S Balance	39
THE PROCESSING OF ULTRAMID®		40-55
	Processing characteristics	40
	General notes on processing	42
	Machine and mold technique for injection molding	43
	Injection molding	46
	Special methods	52
	Machining	52
	Joining methods	53
	Printing, embossing, laser marking, surface coating, metallizing	54
	Conditioning	55
	Annealing	55
GENERAL INFORMATION		56-66
	Safety notes	56
	Quality and environmental management	57
	Quality assurance	57
	Delivery and storage	59
	Colors	59
	Ultramid® and the environment	60
	Services	61
	Nomenclature	62
	Subject index	64

Ultramid® in automotive applications

The very high quality and safety standards in modern automotive engineering make high demands on the materials used. Ultramid® offers high thermal stability, dynamic strength, impact resistance and long-term performance.

These technical properties of Ultramid® can be combined in an exceptional manner with intelligent concepts in today's automotive industry. Here, on account of its broad functionality Ultramid® has great potential for the economically optimized production of structural components and modules. Further criteria such as lightweight construction, recyclability and integrated system solutions combining different materials show the superiority of Ultramid® in comparison with conventional materials.



Pedal block

Examples of typical applications for Ultramid® in automotive engineering:

Engine and gears: inlet pipe and intake manifold, charge air end caps, charge air pipes, cylinder head cover, hood, air mass sensor, oil sump, oil filter housings, oil sensors, chain guide rails, toothed belt covers, transmission controllers, sensors, roller bearing cages, gear wheels, fastening clips

Radiator system: radiator end caps, thermostat housings, coolant pipes, fan wheels, fan frames

Fuel supply system: fuel filter housings, fuel lines, quick-action couplings

Suspension: engine bracket, torque support, torque roll restrictor, transmission cross beam, bodywork and add-on parts

Interior: pedals and pedal brackets, levers and operating elements, speaker grilles, door handles, seat structures

Exterior: structural parts, exterior door handles, mirror base, wheel covers, front end, crash absorbers, lower bumper stiffener (LBS)

Electrical system: cable harnesses, straps and connectors, lamp holders, fuse boxes, contact and brush holders, cable ducts, actuators and actuating drives



Loudspeaker grills



Air and oil suction module



Heat shield



Oil pan

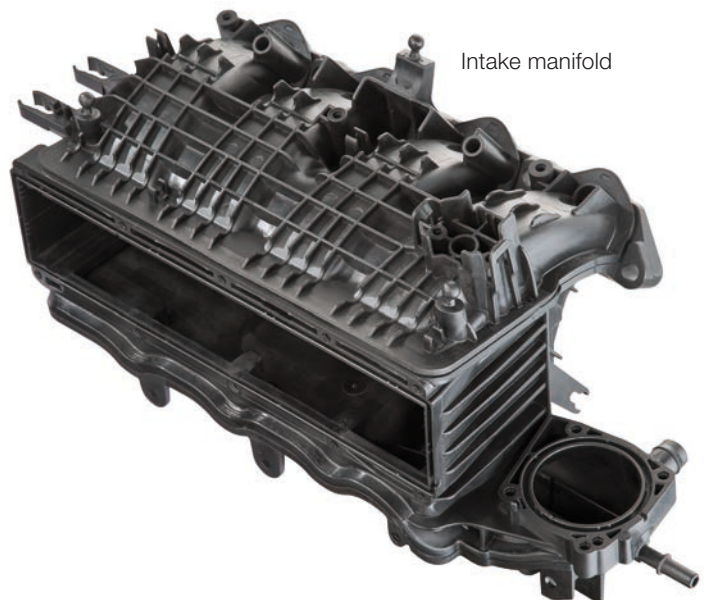

Intake manifold

Ultramid® in the electrical and electronics sector

The good electrical insulation properties, attractive sliding friction behavior, outstanding mechanical strength and a wide range of flame-retardant grades make Ultramid® a material that is used in virtually all areas of industrial power engineering, electronics and domestic appliance technology.

Power technology

High-insulation switch parts and housings, series and connecting terminals, power distribution systems, cable ducts and fastenings, contactors and power switches, coils, circuit breakers, programmable logic controllers

Electronics

Plug-in connectors, electrical and mechanical components for EDP equipment and telecommunications, capacitor cans, chip carriers

Domestic appliances

Components for domestic appliances such as switches, magnetic valves, plug-in devices, program control equipment, housings for electric power tools; electrical equipment and housing parts for large domestic appliances such as washing machines and dishwashers and smaller appliances such as coffee machines, electric kettles and hair dryers

Photovoltaics

Connection boxes and plug-in connectors

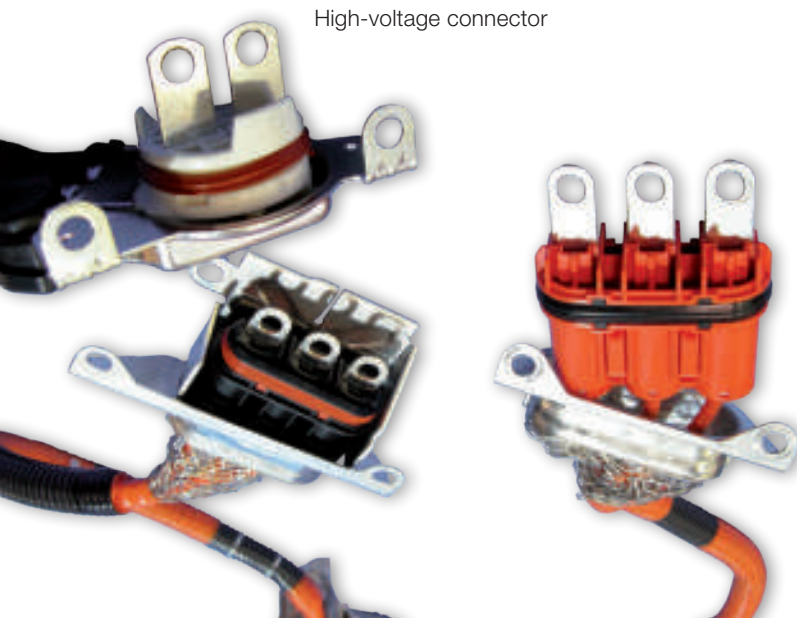

High-voltage connector

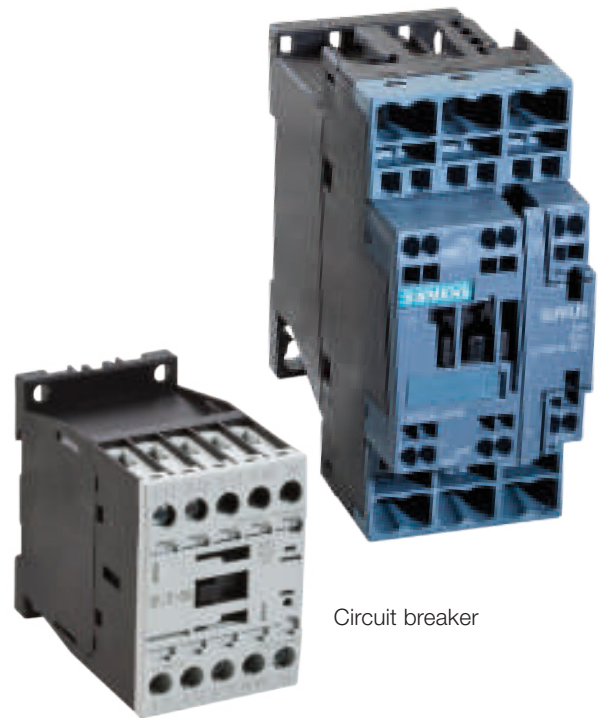

Circuit breaker

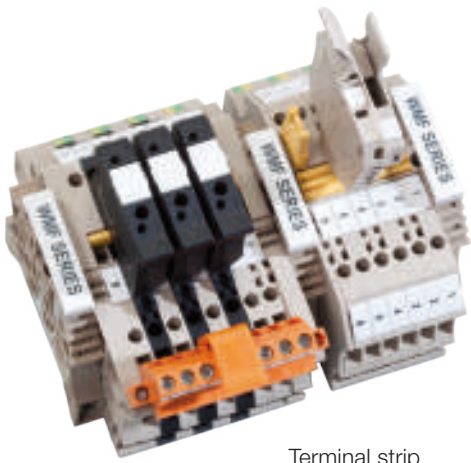

Terminal strip

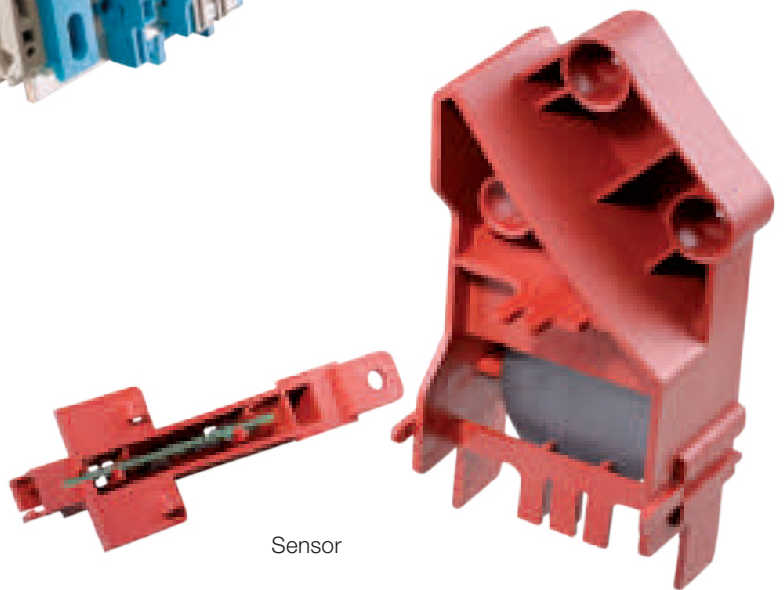
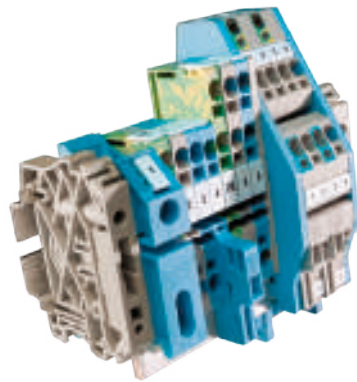

Sensor



Photovoltaic box



Microswitch

Ultramid® for industrial products and consumer goods

High mechanical resilience combined with good toughness, but in particular also the wide range of possibilities for product customization, result in a wide variety of applications for Ultramid® in the field of consumer goods and industrial products. These are firstly applications demanding high mechanical properties where traditional materials such as metal or wood are frequently replaced by plastics with tailor-made properties. Secondly Ultramid® is also increasingly being used in areas in which approval issues play a crucial role. For example, there are special products for applications with food contact.

The varied and in some cases tailor-made properties result in extensive application areas:

Construction and installation engineering

Wall and facade dowels, fastening elements for use on facades and in solar technology, thermal insulation profiles for windows

Sanitary technology

Handles, brackets, fixtures, fans, constant-flow heaters, fittings, water meter housings

Household

Seating, chair castors and braces, cooking sets, furniture brackets

General mechanical and instrument engineering

Ball bearing cages, gear wheels, drives, seals, housings, flanges, joining elements, screws, sliding elements

Materials handling technology

Rollers, rope pulleys, bearing bushes, transport containers, conveyor belts, conveyor chains



Design chairs



Dowels



Frames for office chairs



Cooking set



Ax handle



Ski binding

The properties of Ultramid®

Product Range

Ultramid® is the trade name for polyamides supplied by BASF for injection molding and extrusion. The product range includes PA6 grades (Ultramid® B), PA66 grades (Ultramid® A), special polyamides like PA6T/6 (Ultramid® T) and PA610 (Ultramid® S Balance) as well as special grades based on copolyamides. Ultramid® A is produced by condensation polymerization of hexamethylene diamine and adipic acid, Ultramid® B by hydrolytic polymerization of caprolactam. These materials are obtained from petrochemical feedstocks such as benzene, cyclohexane and p-xylene.

Many products are reinforced with glass fibers or other fillers and contain special additives to improve toughness, flame-retardant properties or resistance to environmental influences in order to allow a wide range of different properties. Specialty polyamides also offer further benefits such as high dimensional stability and chemical resistance.

The most important characteristics of Ultramid® are:

- High strength and rigidity
- Very good impact strength
- Good elastic properties
- Outstanding resistance to chemicals
- Dimensional stability
- Low tendency to creep
- Exceptional sliding friction properties
- Simple processing

The basis of the Ultramid® grades are polyamides which are supplied in a variety of molecular weights or viscosities, have a range of additives and are reinforced with glass fibers or minerals. More detailed information on the individual products can be found in the Ultramid® product range and the tables 1, 2 and 3.



Design chairs

The Ultramid® range comprises the following groups of products:

Ultramid® A

(unreinforced) is the material with the greatest hardness, rigidity, abrasion resistance and thermostability. It is one of the preferred materials for parts subject to mechanical and thermal stresses in electrical, mechanical and automotive engineering.

Ultramid® B

(unreinforced) is a tough, hard material affording parts with good damping characteristics and high shock resistance even in dry state and at low temperatures. It is distinguished by particularly high impact resistance and ease of processing.

Ultramid® C, D

This is the name given to copolyamides made from PA6 or PA66 monomers and further components. They exhibit different properties according to their composition.

Ultramid® S Balance

is particularly resistant to chemicals and is also noted for its low moisture absorption. Ultramid® S Balance is preferably used in components that come into contact with media.

Ultramid® T

has a partially aromatic structure and is a highly rigid material with a high melting point, noted for its dimensional stability, high chemical resistance and constant mechanical properties across a wide range of different applications.

Glass-fiber reinforced Ultramid®

These materials are distinguished by high mechanical strength, hardness, rigidity, thermostability and resistance to hot lubricants and hot water. Parts made from them have particularly high dimensional stability and creep strength. Glass-fiber reinforced Ultramid® T is moreover exceptional for its extraordinarily high heat resistance (up to 280 °C). The portfolio is supplemented by long glass-fiber reinforced Ultramid® Structure LF grades.

Reinforced and unreinforced grades with flame retardants

Ultramid® grades with special additives including C3U, A3X2G5, A3X2G7, A3X2G10, A3U40G5, B3UG4, B3U30G6 and T KR 4365 G5 are particularly suitable for electrical parts required to meet enhanced specifications for fire safety and tracking current resistance.

Mineral-filled Ultramid®

The special advantages of these materials reinforced with minerals and glass beads lie in increased rigidity, good dimensional stability, low tendency to warp, optically appealing surfaces and good flow characteristics.

Ultramid®	Polyamide	Chemical structure	Melting point [°C]
Ultramid® A	66	basis hexamethylene diamine, adipic acid	260
Ultramid® B	6	polycaprolactam – NH(CH ₂) ₅ CO	220
Ultramid® S Balance	610	basis hexamethylene diamine, sebacic acid	222
Ultramid® T	6T/6	copolymer of caprolactam hexamethylene diamine and terephthalic acid	295

Table 1: Ultramid® grades

Ultramid® A		F ¹⁾	W ²⁾		
Injection molding grades (unreinforced)	A3K	✓	Yellow	easy flowing, fast processing	
	A3W		Red		
	A4K	✓	Yellow	medium viscosity, high impact strength even at dry state	
	A4H		Orange		
	A3Z		Yellow	impact-modified to give high impact strength even at dry state and low temperatures	
	A3...Z1...3	✓	Yellow	medium to highest level of toughness, fast processing	
	Special product				
A3K FC Aqua®			Yellow	with material approvals for drinking water or food contact	
Injection molding grades (reinforced)	A3EG3...10	✓	Yellow	good dielectric properties	
	A3HG3...7		Orange	high heat-aging resistance even in contact with lubricants combined with good dielectric properties	
	A3WG3...10		Red	very high heat-aging resistance	
	A3ZG3...6		Yellow	impact-modified to give high impact strength even at dry state and low temperatures	
	A3K6		Yellow	glass bead reinforcement to achieve high dimensional stability, low warpage, and good surface appearance	
	A3WGM53		Red	glass and mineral reinforced grade with medium rigidity and strength as well as low warpage	
	Special products				
	A3EG6...7 FC Aqua®			Yellow	with material approvals for drinking water or food contact
	A3EG6...7 EQ			Yellow	meets special purity requirements for sensitive applications in electronic industry
	A3HG6 HR			Orange	with improved hydrolysis resistance
	A3WG6...7 HRX			Red	with further improved hydrolysis resistance
	A3HG6 WIT			Orange	with improved hydrolysis resistance and suited for processing by water injection technology (WIT)
	A3W2G6...10			Red	with further improved heat-aging resistance
	A3WG7 HP			Red	with good flow and surface properties
	A3WG6 LT			Red	laser transparent black material for laser welding
	A3WG7...10 CR			Red	for highly loaded parts, can be optimized with Ultrasim®
	A3WC4			Red	with carbon fiber reinforcement
	Structure A3WG8...12 LF			Red	with long glass fiber reinforcement
	Ultramid® B				
	Injection molding grades (unreinforced)	B3K	✓	Yellow	easy flowing, fast processing, high impact strength once conditioned
B3S		✓	Yellow		
B3W				Red	medium viscosity
B35W				Red	
B3L		✓		Yellow	impact-modified to give high impact strength even at dry state
B3Z1...4		✓		Yellow	increasing level of toughness even at dry state and very low temperatures
B35WZ4				Yellow	
Special product					
B3S HP				Yellow	demolding optimized to achieve very fast cycle time

Table 2: Ultramid® product range

¹⁾ Available in different colors (apart from black and natural)

²⁾ Level of heat stability:  low high

Ultramid® B		F ¹⁾	W ²⁾		
Injection molding grades (reinforced)	B3G3...9	✓		fiber-reinforced products	
	B3EG3...10	✓	Yellow	good dielectric properties	
	B3E2G3...6		Yellow	UV-stabilized to match requirement for automotive interior	
	B3WG3...10		Dark Red	very high heat-aging resistance	
	B3ZG3...8		Yellow	impact-modified to give high impact strength even at dry state and low temperatures	
	B3GK24	✓	Yellow	glass-fiber and glass-beads filler, low warpage	
	B3K3...6	✓	Yellow	glass-bead reinforced to achieve high dimensional stability, low warpage and good surface appearance	
	B3WGM24...45		Dark Red	glass-fiber and mineral filler; with medium to high rigidity and strength, low warpage	
	B3WGM24 HP		Dark Red		
	B3M6		Yellow	mineral filler; with medium rigidity and strength, low warpage	
	Special products				
	B3EG4...10 SI		Yellow	surface improved for excellent visual appearance and smoothness	
	B3WG6...8 High Speed		Dark Red	excellent flow properties	
	B3WG6 GP		Dark Red	optimized for vibration welding, main application: air intake manifolds	
	B3WG6 GIT		Dark Red	suited for processing by gas injection technology (GIT)	
	B3WG6 SF		Dark Red	suited for foaming processes like MuCell	
	B3WG6 CR		Dark Red	for highly loaded parts which require optimisation with Ultrasim®	
	B3ZG3...10 CR		Yellow		
	Structure B3WG8...10 LF		Dark Red	with long glass fiber reinforcement	
Ultramid® D					
Injection molding grades (reinforced)	D3EG10 FC Aqua®		Yellow	high stiffness and low water uptake; with material approvals for drinking water or direct food contact	
	D3G7...10 Endure		Dark Red	highest level of heat aging resistance	
Ultramid® S					
Injection molding grades (unreinforced)	S3K Balance		Yellow	easy flowing, fast processing	
Injection molding grades (reinforced)	S3EG6 Balance		Yellow	good dielectric properties	
	S3WG6...7 Balance		Dark Red	very high heat-aging resistance	
Ultramid® T					
Injection molding grades (unreinforced)	T KR 4350		Orange	easy flowing, fast processing	
Injection molding grades (reinforced)	T KR 4355 G5...10		Orange	fiber-reinforced products	
	T KR 4357 G6		Orange	fiber-reinforced and impact-modified	
	Special products				
	T KR 4355 G5 LS		Orange	especially suitable for laser markable parts	
	T 4381 LDS		Orange	for laser direct structuring	

Table 2: Ultramid® product range

¹⁾ Available in different colors (apart from black and natural)

²⁾ Level of heat stability:  low high

	Product	UL 94	GWIT ≥ 775 GWFI ≥ 850 d = 1.5 mm	Halogen-free flame retardant	Symbol
Ultramid® unreinforced	A3K	V-2, 0.4	+	+ ¹⁾	PA66
	A3U30	V-0, 0.25	+	+	PA66 FR
	C3U	V-0, 0.4	+	+	PA6/66 FR
	B3S	V-2, 1.5	+	+ ¹⁾	PA6
Ultramid® reinforced	A3U40G5	V-0, 0.4	+	+	PA66 GF25 FR
	A3X2G5	V-0, 0.8		+	PA66 GF25 FR
	A3XZG5	V-0, 1.5		+	PA66-I GF25 FR
	A3X2G7	V-0, 0.75		+	PA66 GF35 FR
	A3X2G10	V-0, 1.5		+	PA66 GF50 FR
	B3UG4	V-2, 0.71		+	PA6 GF20 FR
	B3U30G6	V-2, 0.75		+	PA6 GF30 FR
	B3UGM210	V-0, 1.5		+	PA6 GF10-M50 FR
	T KR 4365 G5	V-0, 0.75	+	+	PA6T/6 GF25 FR
	T KR 4340 G6	V-0, 0.4	+	+	PA6T/6 GF30 FR

Table 3: Overview of reinforced and unreinforced grades with flame retardants

¹⁾ Product does not contain flame-retardant additive



Electrical household appliances	Terminal blocks	Connectors	Circuit breakers	Low-voltage switch gears	Photovoltaics	Automotive construction	Railway vehicles
●	○	○			○	○	
○	●	○		○		○	○
○	●	○		○		○	○
●	○	○				○	
●		○	○	○		●	○
		○		●	●	●	○
		○		○	●	●	○
		○		●	●	●	○
		○		○		●	○
		○	●	○	○		○
		○	●	○			○
		○	○	○			●
○		○		●		○	○
		○	○	○		○	

● Main field of application ○ Other fields of application

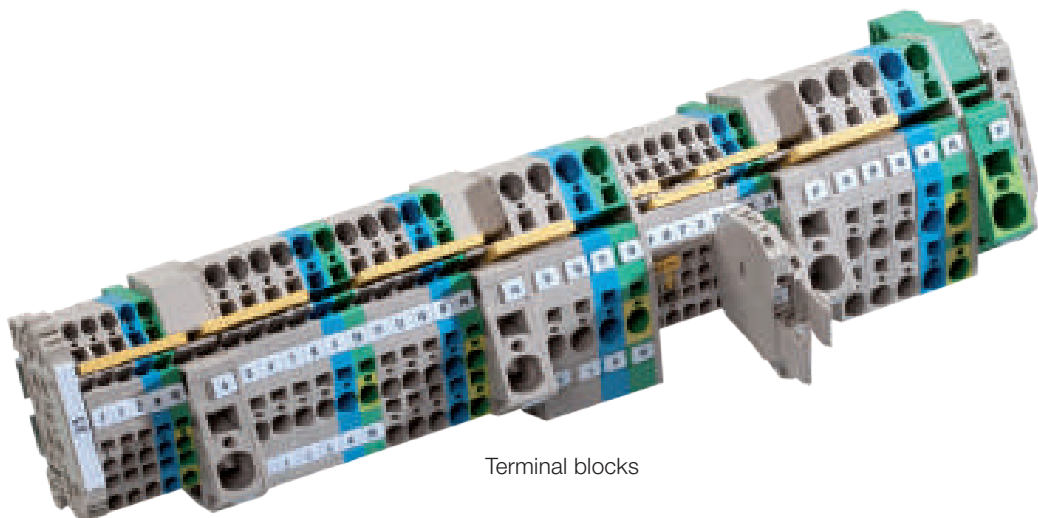

Terminal blocks

Mechanical properties

The Ultramid® A (PA66) and Ultramid® B (PA6) grades which are described here offer various combinations of mechanical properties and thus meet a variety of requirements for example from the E&E and automotive industries as well as from numerous other sectors.

Special about polyamide as a material is its ideal combination of strength, rigidity and toughness together with excellent longevity across a wide temperature range. These advantages can be attributed to the partially crystalline structure of the polyamide: strong hydrogen bridge bonds between molecules give strength to the crystalline areas and allow high operating temperatures, while more flexible molecule chains in the amorphous regions ensure exceptional toughness.

When choosing materials on the basis of key mechanical data, one special feature of the polyamide must be taken into account: freshly molded components are always dry and will absorb moisture depending on the ambient conditions. This leads to a considerable change in the key mechanical data, in particular in typical test conditions of 23°C. This is why in the data sheets a distinction is frequently made between the key material data “dry” and “conditioned”.

As an example for Ultramid® A and Ultramid® B, Fig. 1 shows unreinforced Ultramid® A3K to demonstrate the influence of conditioning on the tensile modulus of elasticity (shift in the glass transition temperature). In the case of Ultramid® A3EG10, a product which is reinforced with a glass fiber content of 50%, the moisture absorption is reduced as this takes place exclusively in the PA matrix (in the amorphous regions).

In the following text, the mechanical properties of the Ultramid® range are described on the basis of dry test specimens.

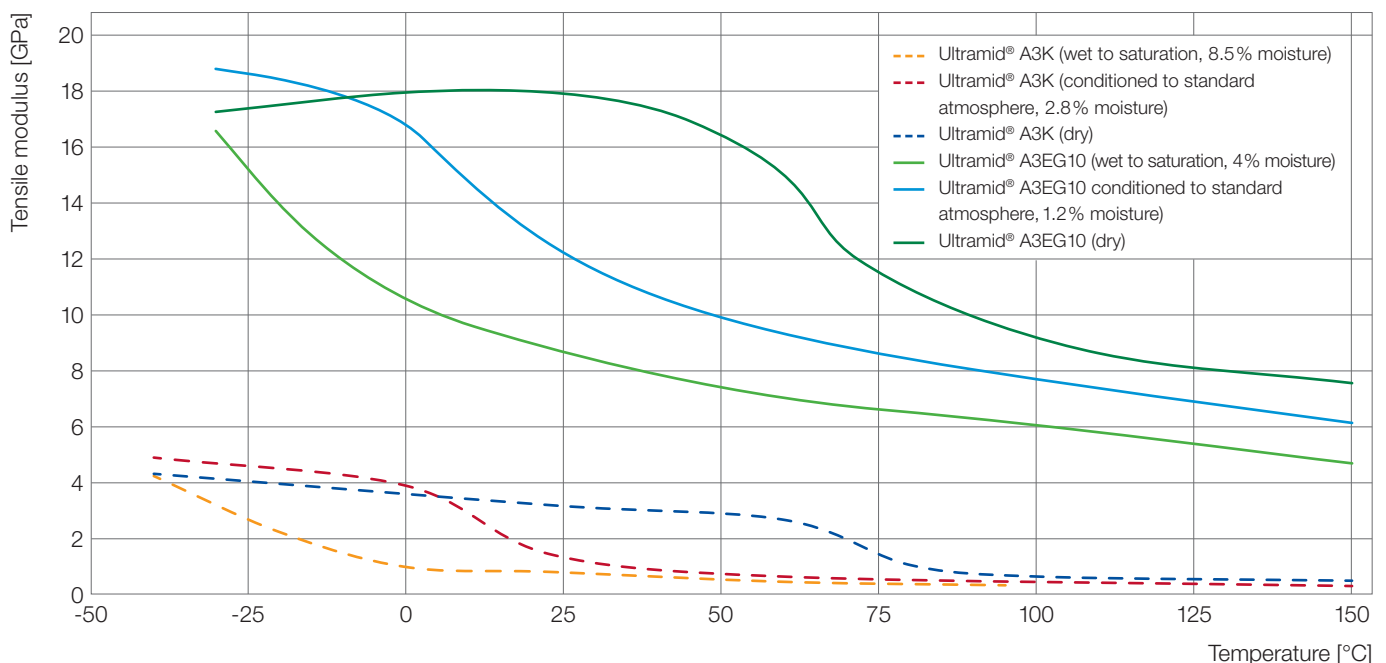

Fig. 1: Tensile modulus of Ultramid® A3K and A3EG10 as a function of the temperature and moisture

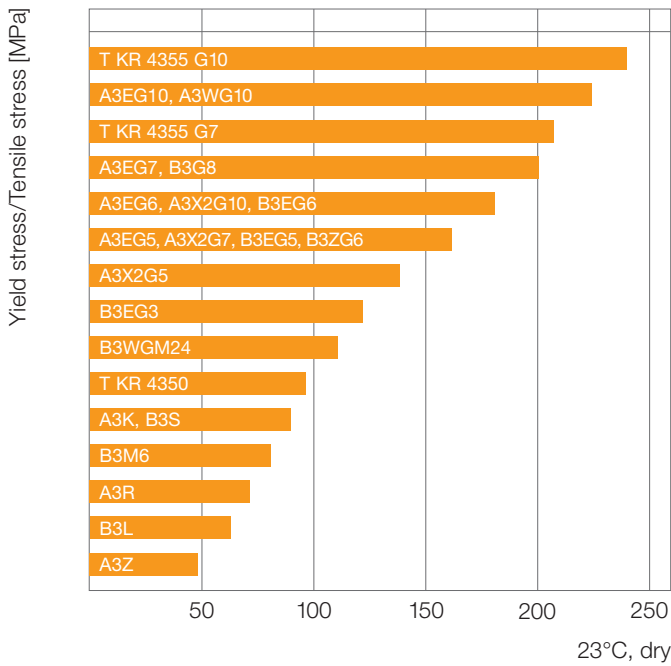

Fig. 2: Yield stress (tensile stress in the case of reinforced grades) for selected Ultramid® grades at 23 °C in the dry state (ISO 527)

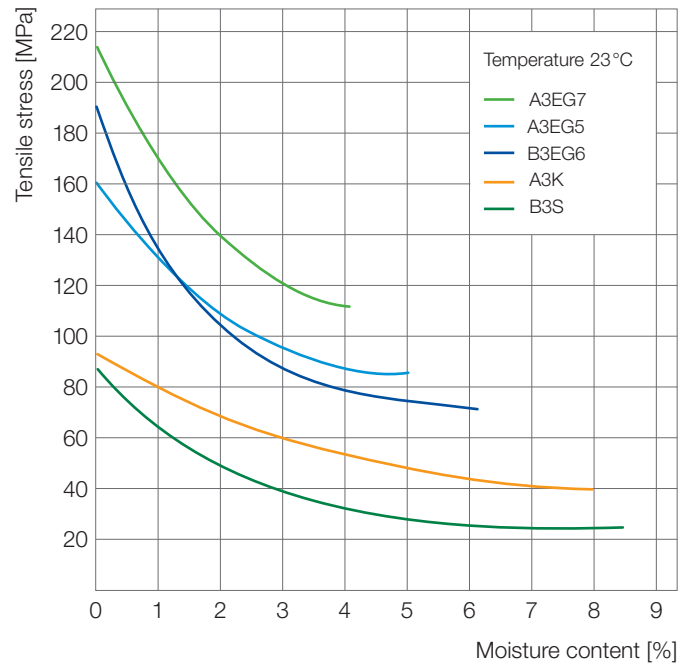

Fig. 4: Tensile stress (yield stress in the case of unreinforced grades) for Ultramid® as a function of moisture content at 23 °C (ISO 527)

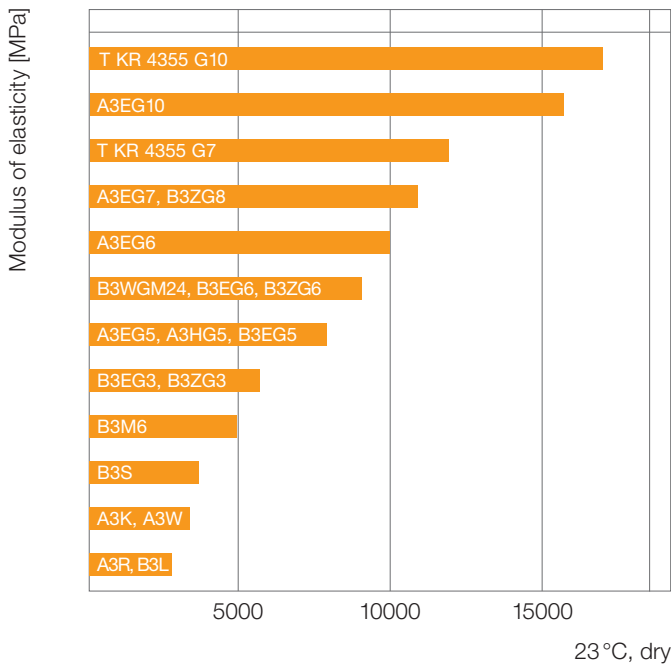

Fig. 3: Modulus of elasticity for selected Ultramid® grades at 23 °C in the dry state (ISO 527)

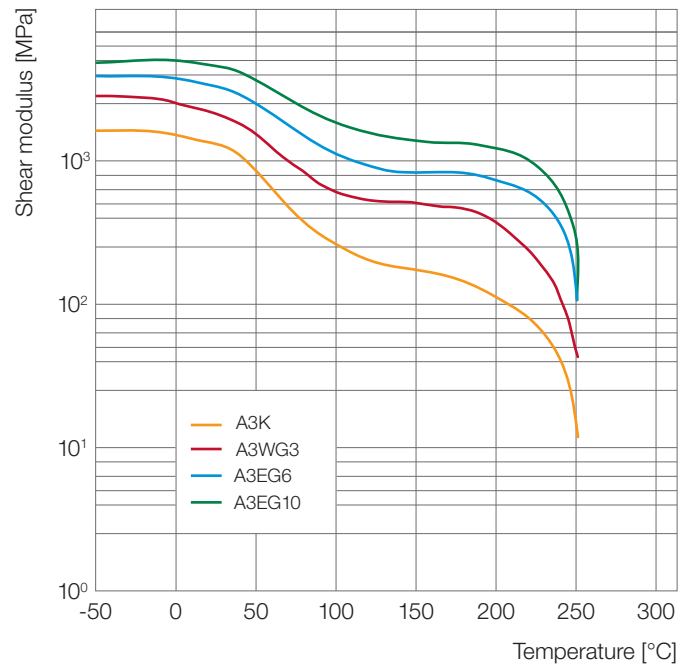

Fig. 5: Shear modulus of Ultramid® A grades as a function of temperature (ISO 6721-2, dry) and glass fiber content

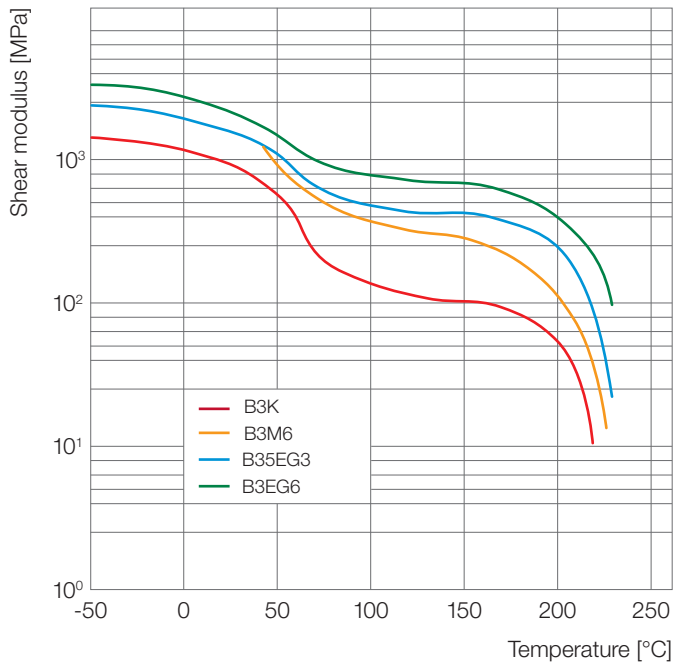

Fig. 6: Shear modulus of Ultramid® B grades as a function of temperature (ISO 6721-2, dry)

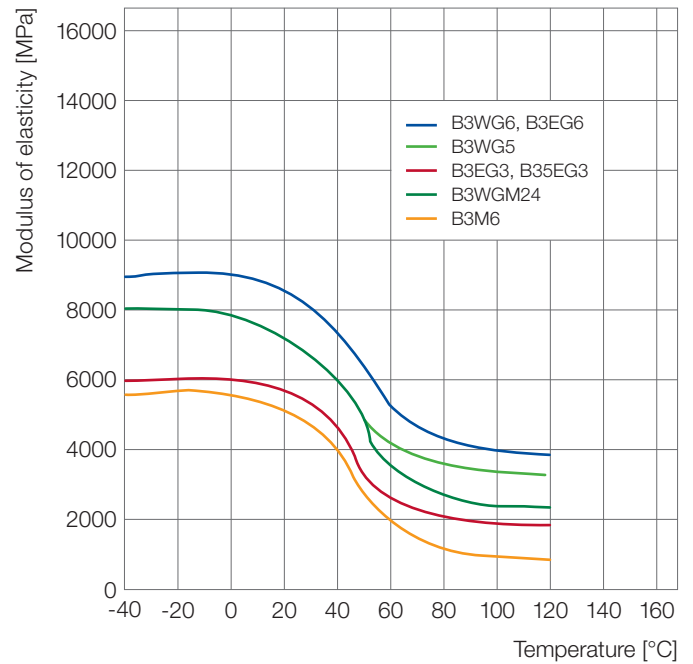

Fig. 8: Modulus of elasticity of reinforced Ultramid® B grades as a function of temperature (Flexural test ISO 178, dry)

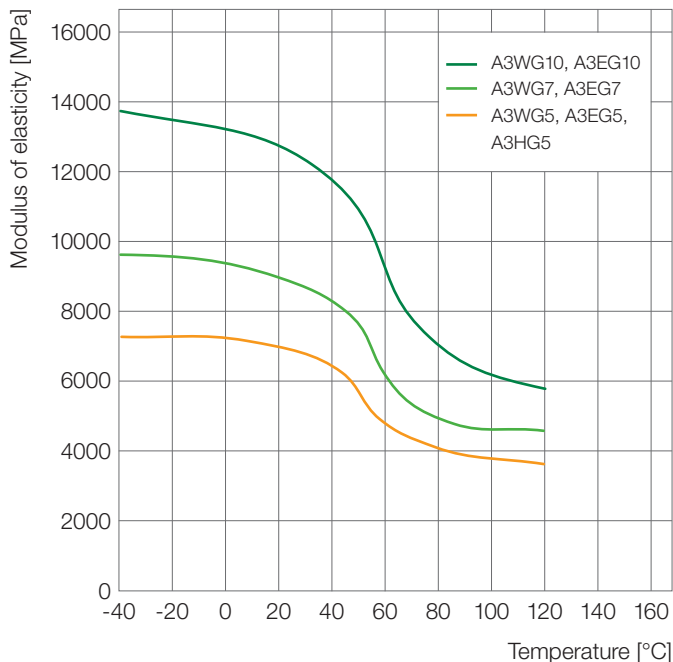

Fig. 7: Modulus of elasticity of reinforced Ultramid® A grades as a function of temperature (Flexural test ISO 178, dry)

The product range can be classified by six groups according to the modulus of elasticity:

- Impact-modified unreinforced grades 1500 - 2000 MPa
- Unreinforced grades 2700 - 3500 MPa
- Mineral-filled, impact-modified grades (+GF) 3800 - 4600 MPa
- Mineral-filled grades (+GF) 3800 - 9300 MPa
- Impact-modified, glass-fiber reinforced grades 5200 - 11200 MPa
- Glass-fiber reinforced grades 5200 - 18000 MPa

The mechanical properties are affected by the temperature, time and moisture content and by the conditions under which the test specimens were prepared (see product-specific processing data sheets).

In the case of the reinforced grades, the modifications have an influence on the properties. The most important modification is the reinforcement with glass fibers. Influencing factors are: glass fiber content, average glass fiber length, glass fiber length distribution and the glass fiber orientation. The latter is formed by the flow process of the melt and results in anisotropic component properties. These effects can be calculated quantitatively and introduced for the purpose of optimizing components. BASF uses its Ultrasim® simulation tool to do this. The data is shown for uncolored products and may be influenced by coloring.

The yield stress of dry, unreinforced Ultramid® ranges from 70 to 100 MPa while the stress at break of the reinforced grades rises as high as 250 MPa. The behavior under short-term uniaxial tensile stress is presented as stress-strain diagrams (Figs. 9 and 10) in which the effects of temperature and reinforcement are illustrated. High creep strength and low tendency to creep are also shown, especially in the reinforced grades.

Impact strength, low-temperature impact strength

Polyamides are very tough materials. They are suitable for parts required to exhibit high resistance to fracture. Standard test values generally determined under different conditions are used to characterize their impact behavior (see the Ultramid® product range).

Although the values are not directly comparable with one another due to the differing test setups, test specimen dimensions and notch shapes, they do allow comparison of molding materials within the individual product groups. Tests on finished parts are indispensable for the practical assessment of impact behavior. However, the behavior of Ultramid® when subjected to impact is affected by many factors, of which the most important are the shape of the part, the rigidity of the material and the moisture content.

There are Ultramid® grades with the most varied combinations of impact strength and rigidity. Depending on application, requirements, design and processing, products which are unreinforced, of relatively high molecular weight, glass-fiber reinforced, mineral-filled or impact modified can be selected each having an optimum relationship between impact strength and rigidity. The advice below should also be taken into account when choosing suitable materials.

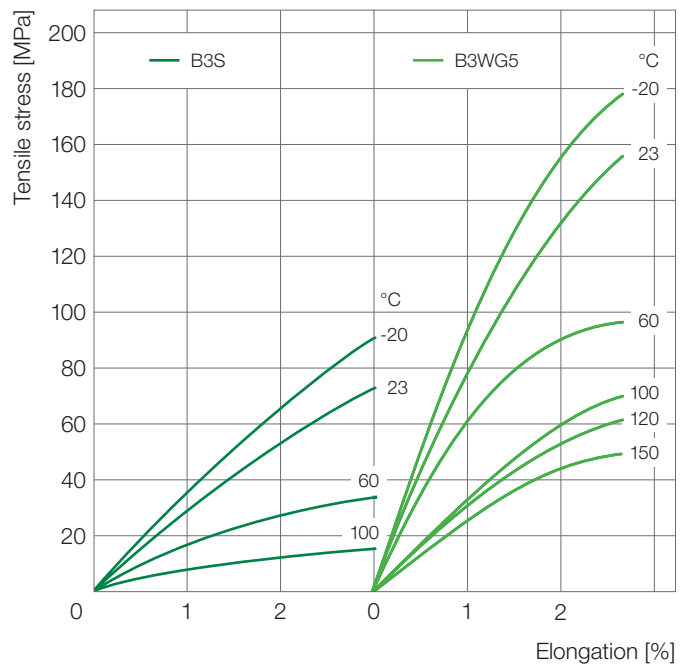

Fig. 9: Stress-strain diagrams for Ultramid® B3S and B3WG5 (dry) in accordance with ISO 527 (test speed 2 mm/min)

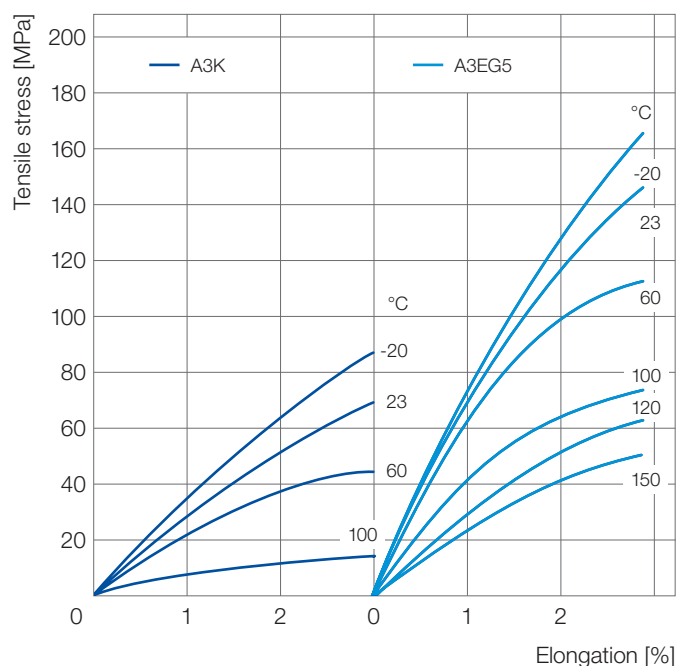

Fig. 10: Stress-strain diagrams for Ultramid® A3K and A3EG5 (dry) in accordance with ISO 527 (test speed 2 mm/min)

Moisture promotes the toughness of Ultramid®, even at low temperatures. In the case of glass-fiber reinforced grades the impact strength of finished parts decreases as the glass fiber content rises while strength and the values in the flexural impact test for standardized test specimens increase. This effect is due to differences in the orientation of the glass fibers.

Unreinforced products of high molecular weight have proved to be effective for thick-walled engineering parts required to exhibit high impact strength.

Even in the dry state the impact-modified, unreinforced Ultramid® grades like B3L exhibit high impact strength. They are employed when conditioning or intermediate storage for absorption of moisture are uneconomic or when extremely high notched or low-temperature impact strength are called for.

Apart from the particular processing conditions, the geometry of the molding – with the resultant moments of resistance – and especially the wall thicknesses and the notch radii also play a major role in determining the fracture energy. Even the speed and point of impact significantly affect the results.

Behavior under long-term static loading

The static loading of a material for relatively long periods is marked by a constant stress or strain. The tensile creep test in accordance with ISO 899 and the stress relaxation test in accordance with DIN 53441 provide information about extension, mechanical strength and stress relaxation behavior under sustained loading.

The results are presented as creep curves, creep modulus curves, creep stress curves and isochronous stress-strain curves (Figs. 11 and 12). The graphs for standard conditions (in accordance with ISO 291) reproduced here are just a selection from our investigations.

Further values and diagrams for different temperature and atmospheric conditions can be requested from the Ultra-Infopoint or found in the program “Campus”. Design data obtained from uniaxial tensile loads can also be used to assess the behavior of a material under multiaxial loads.

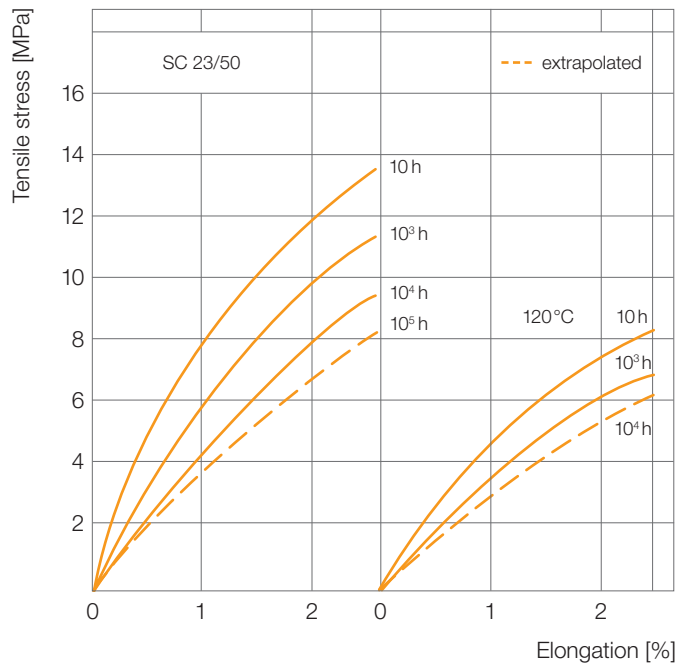

Fig. 11: Isochronous stress-strain curves for Ultramid® A3K in accordance with ISO 899 under standard atmospheric conditions (23/50) and at 120°C (in the dry state)

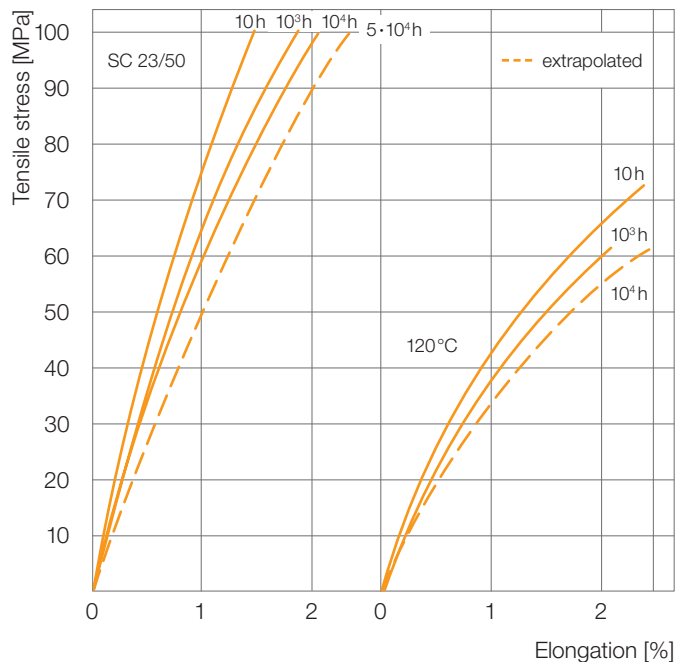

Fig. 12: Isochronous stress-strain curves for Ultramid® A3WG10 in accordance with ISO 899 under standard atmospheric conditions (23/50) and at 120°C (in the dry state)

Behavior under cyclic loads, flexural fatigue strength

Engineering parts are also frequently subjected to stress by dynamic forces, especially alternating or cyclic loads, which act periodically in the same manner on the structural part. The behavior of a material under such loads is determined in long-term tests using tensile and compressive loading alternating at up to very high load-cycle rates. The results are presented in Woehler diagrams obtained by plotting the applied stress against the load-cycle rate achieved in each case (Fig. 13). When applying the test results in practice it has to be taken into account that at high load alternation frequencies the workpieces may heat up considerably due to internal friction. In such cases the curves measured at higher temperatures have to be used (Fig. 13).

Tribological behavior

A smooth, tough and hard surface, crystalline structure, high thermostability and resistance to lubricants, fuels and solvents make Ultramid® an ideal material for parts subjected to sliding friction. Its good dry-running properties are worth pointing out.

Whereas metallic materials tend to jam under dry-running conditions, pairings with Ultramid® run satisfactorily even without lubrication.

Wear and friction are system properties which depend on many parameters, e.g. on the paired materials, surface texture and geometry of the sliding parts in contact, the intermediate medium (lubricant) and the stresses due to external factors such as pressure, speed and temperature.

The most important factors determining the level of wear due to sliding friction and the magnitude of the coefficient of sliding friction are the hardness and surface roughness of the paired materials, the contact pressure, the distance traversed, the temperature of the sliding surfaces and the lubrication.

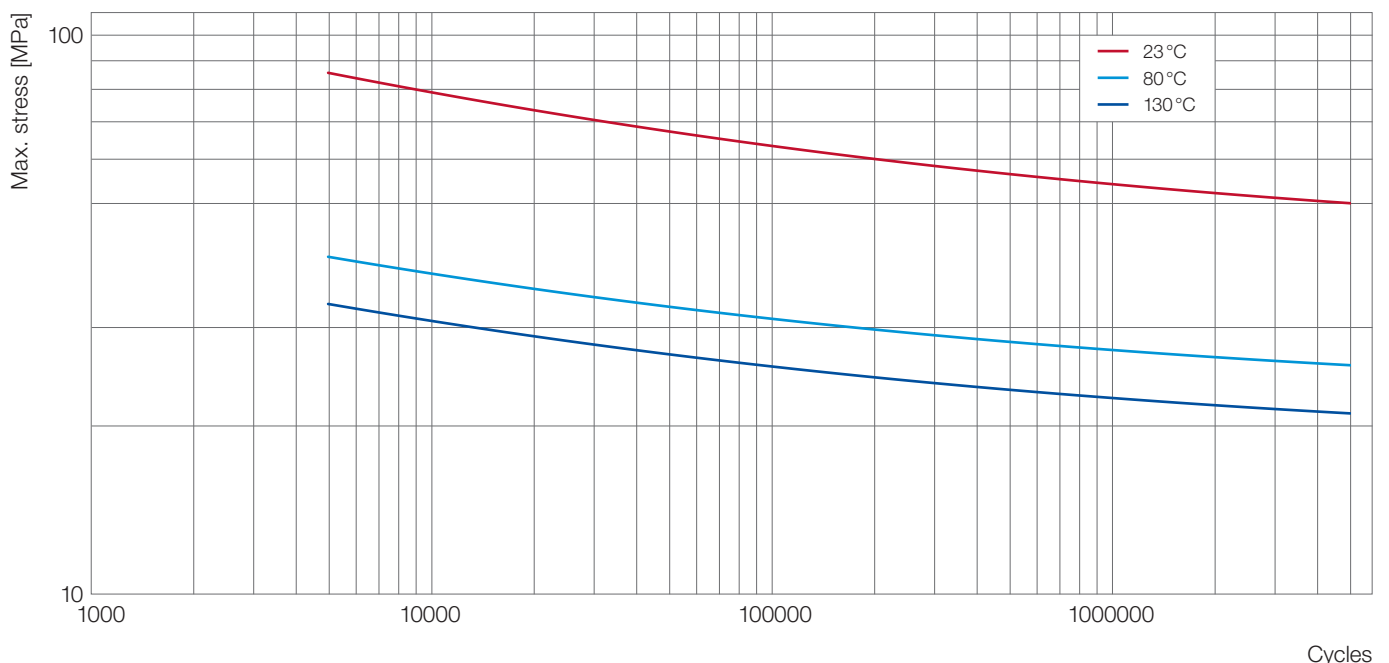

Fig. 13: Fatigue of Ultramid® A3WG7 at different temperatures (dry, R = -1, 10 Hz, lengthwise oriented, thickness = 3 mm)

Thermal properties

Ultramid® has the following melting temperatures:

Ultramid® A:	260 °C
Ultramid® B:	220 °C
Ultramid® C:	243 °C
Ultramid® S:	222 °C
Ultramid® T:	295 °C

Due to its semicrystalline structure and strong hydrogen bonding Ultramid® retains its shape even at elevated temperatures close to the melting range.

Ultramid® stands out among other partially crystalline thermoplastics due to its low coefficients of linear expansion.

The reinforced grades in particular exhibit high dimensional stability when exposed to temperature changes. In the case of the glass-fiber reinforced grades, however, linear expansion depends on the orientation of the fibers.

Behavior on heat

Apart from its product-specific thermal properties the behavior of components made from Ultramid® on exposure to heat also depends on the duration and mode of application of heat and on the mechanical loading. The design of the parts also has an effect. Accordingly, the thermostability of Ultramid® parts cannot be estimated simply on the basis of the temperature values from the various standardized tests no matter how valuable the latter might be for guidance and comparisons.

The shear modulus and damping values measured as a function of temperature in torsion pendulum tests in accordance with ISO 6721-2 afford valuable insight into the temperature behavior. Comparison of the shear modulus curves (Figs. 5 and 6) provides information about the different thermo-mechanical effects at low deformation stresses and speeds. Based on practical experience the thermostability of parts produced in optimum manner is in good agreement with the temperature ranges determined in the torsion tests in which the start of softening becomes apparent.

The test for heat resistance in accordance with IEC 60695-10-2 (ball indentation test), is usually specified for applications in electrical equipment. The requirements of this test at 125 °C for supports for voltage-carrying parts are met by finished parts made from all grades of Ultramid®. The reinforced grades are recommended for this purpose.



Circuit breaker

Heat aging resistance

Stabilized Ultramid®, identified by K, E, H or W as the second letter in the nomenclature, is suitable for parts which are consistently exposed to high temperatures. Materials with the W2 stabilization (up to 190 °C) and Ultramid® Endure (up to 220 °C) are suitable for extremely high constant temperatures.

The features and effectiveness of this stabilization are summarized in Table 2 using the example of Ultramid® A. The tensile strength as a function of the storage time is shown in Figure 14 for a number of Ultramid® grades.

Code	K	E	H	W
Example without GF	A3K			A3W
Example with GF		A3EG6	A3HG5	A3WG6
Natural color	colorless	colorless	brown	greenish
Effectiveness				
on air 120 °C for σ_{50}				
without GF [days]	200		700	1000
with GF [days]		>1500	>2000	>2000
Hot water, coolants		(•)	•*	•*
Outdoor exposure	•	•	•	•
Engine & transmission oils	•	•	••	•
Dielectric properties	•	•	•	(•)

Table 4: Stabilized Ultramid® A grades

- = particularly suitable
- = suitable
- (•) = suitable, but with limitations
- * = A3HG6 HR, A3WG6/7 HRX

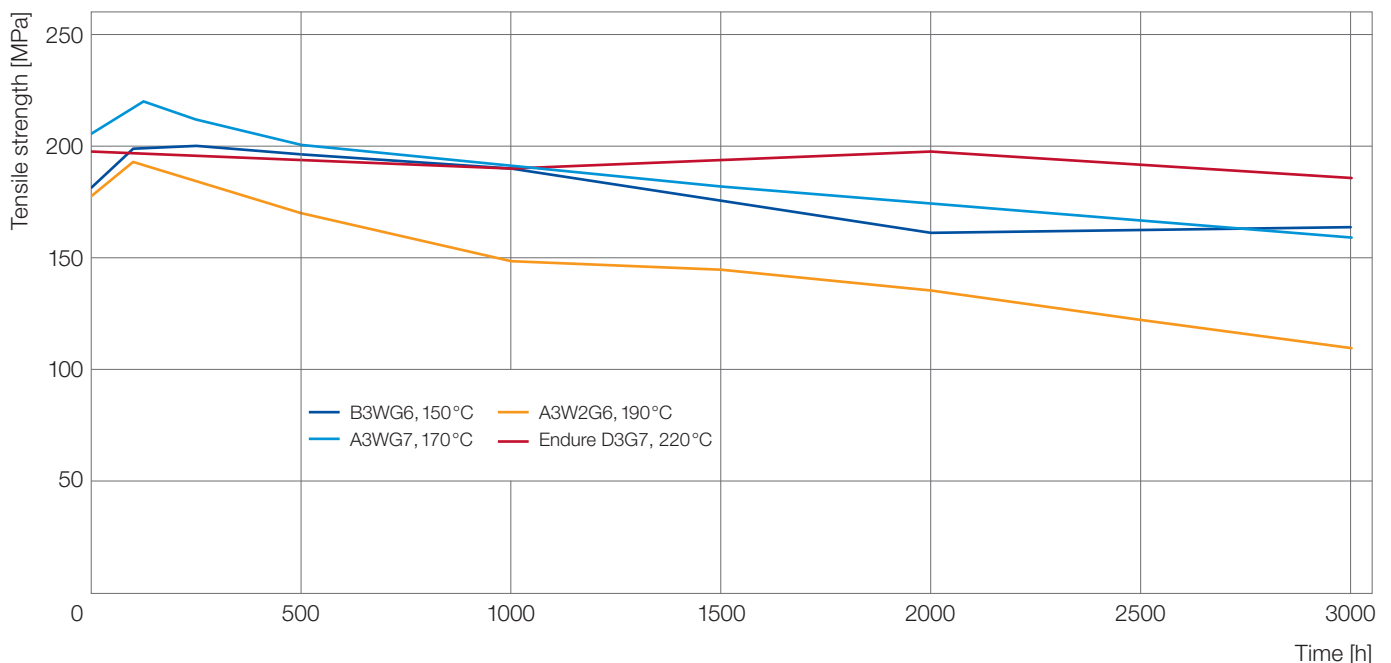

Fig. 14: Heat aging resistance of different Ultramid® types (dry), tensile strength (23 °C)

Heat aging resistance in hot lubricants, coolants and solvents

The widespread application of Ultramid® in engineering, especially in automotive engineering, e. g. in engine oil circuits and gearboxes, is based on its outstanding long-term resistance to hot lubricants, fuels and coolants and to solvents and cleaning agents. Fig. 15 shows how the flexural and impact strengths of Ultramid® A are affected by immersion in hot lubricants (120°C) and coolants. H- and W-stabilized grades are particularly resistant to lubricants and hot coolants. A3HG6 HR has proved to be particularly successful in applications in automobile cooling circuits.

Water absorption and dimensional stability

A special characteristic of polyamides in comparison with other thermoplastics is their water absorption. In water or in moist air depending on its relative humidity and dependant on time, temperature and wall thickness moldings absorb a certain quantity of water so that their dimensions increase slightly. The increase in weight on saturation depends on the Ultramid® grade and is listed in the tables in the range chart. Fig. 16 shows how the absorption of moisture on saturation depends on the relative humidity.

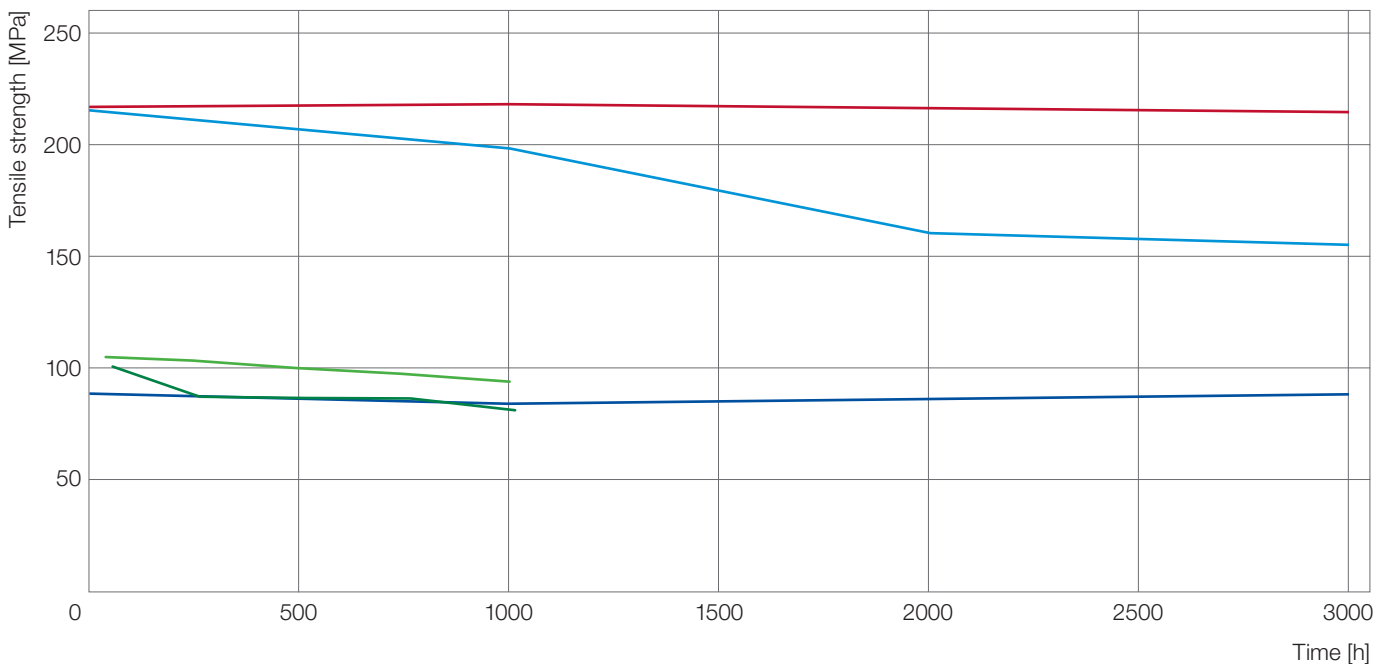

Fig. 15: Tensile strength of different Ultramid® types after storage in different media, tensile strength (23°C)

- A3WG7, Motor oil – Fuchs Titan Supersyn SAE 5W-30, 150°C
- A4H, Lubrication grease – Klüber M 003/04, 120°C
- A3WG7, Gear oil – Dexron VI ATF 2, 150°C
- A3WG7 HRX, Coolant – Glysantin G30 - H₂O 1:1, 130°C
- A3WG7 HRX, Coolant – Glysantin G48 - H₂O 1:1, 130°C

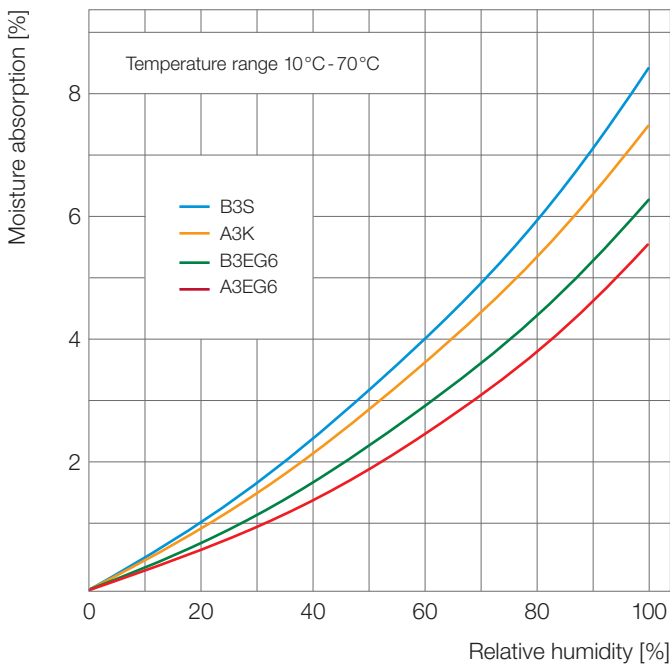

Fig. 16: Equilibrium moisture content of Ultramid® as a function of relative humidity in the temperature range 10°C-70°C (scatter: ± 0.2 to 0.4% absolute)

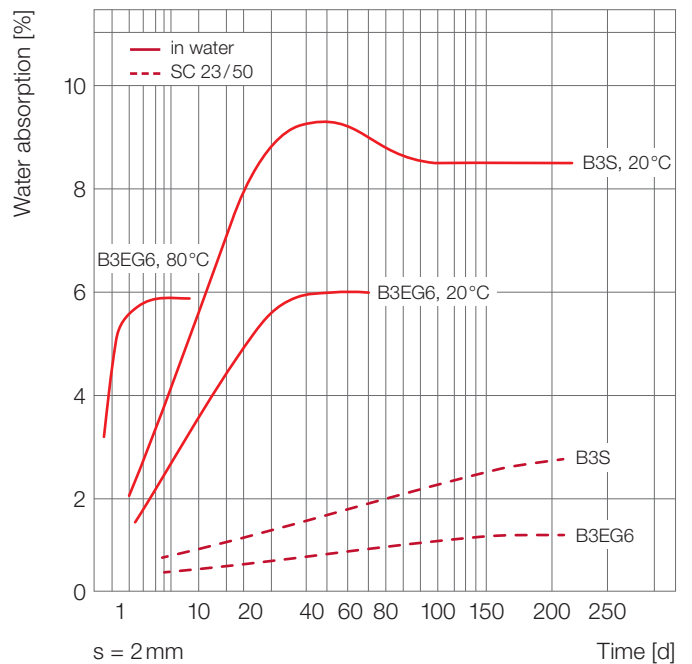

Fig. 17: Water absorption of Ultramid® B as a function of storage time and the conditioning parameters (specimen thickness 2 mm)

Figs. 17 and 18 show the water absorption of Ultramid® as a function of storage time under various test conditions.

As can be seen from the Ultramid® range chart, water absorption results in increased impact strength, elongation at break and tendency to creep whereas strength, rigidity and hardness decrease.

Provided that the water is uniformly distributed in the molding, Ultramid® A and Ultramid® B undergo a maximum increase in volume of about 0.9% and a mean increase in length of 0.2 to 0.3% per 1% of absorbed water. The dimensional change of the glass-fiber reinforced grades amounts to less than 0.1% per 1% in the direction of the fiber orientation (longitudinally). As a result of this the dimensions of these grades, like those of the mineral-filled grades, remain particularly constant when humidity varies.

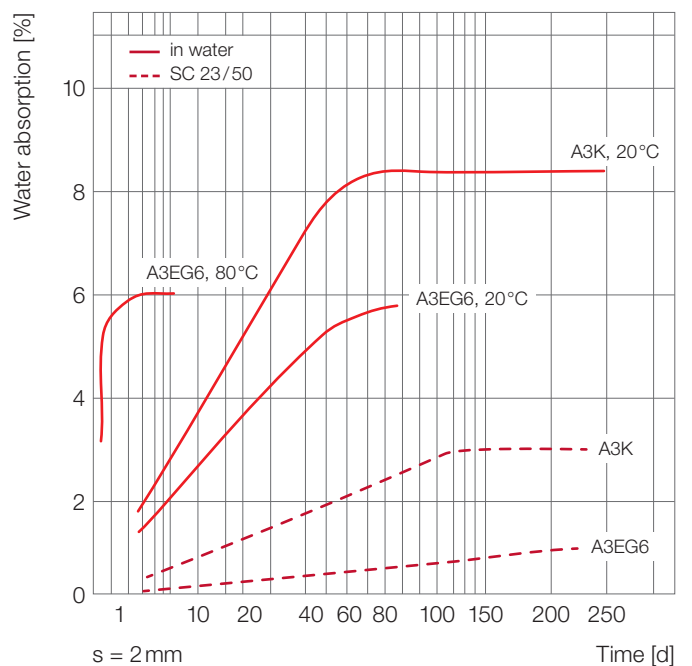

Fig. 18: Water absorption of Ultramid® A as a function of storage time and the conditioning parameters (thickness of specimen 2 mm)

Electrical properties

The paramount importance of Ultramid® in electrical engineering, especially for electrical insulating parts and housings in power engineering, is attributable to its good insulating properties (volume resistance and surface impedance) combined with its impact strength and creep strength as well as its advantageous properties in relation to heat and aging. As a result Ultramid® is numbered among the high-performance insulating materials. Wherever there are high demands on fire properties the flame-retardant grades are preferably used.

The following points should be noted in relation to electrical properties:

- The products are characterized by a high tracking current resistance which is only slightly impaired by the moisture content of the material.
- The specific volume resistance and the surface impedance are very high; these values decline at elevated temperatures and also when the water content is relatively high.
- As for all electrical insulating materials when used in harsh conditions continual wetting due to condensation must be prevented by appropriate design measures.
- Unfavorable operating environments such as hot pockets combined with high air humidity, moist, warm conditions or poor ventilation can adversely affect the insulating properties.

For the above reasons the performance of the components should be carefully checked for each application. The values of the electrical properties are listed in the range chart.

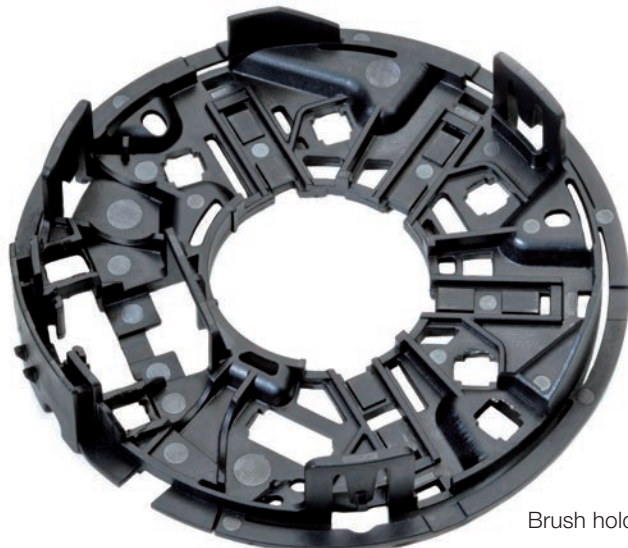

Figs. 19 and 20 show the effect of temperature and moisture on the dielectric strength and specific volume resistivity of Ultramid®.

For an important grade within the flame-retardant product range, i. e. Ultramid® A3X on the basis of red phosphorous, the following applies: The Ultramid® A3X grades contain a special stabilizer to prevent the formation of red phosphorous decomposition products which can occur some in polyamides with phosphorus-based flame retardants. As is the case with all insulators parts made from Ultramid®, especially those intended for use under extreme conditions of heat and humidity, must be carefully designed and tested before usage to ensure they operate reliably. Overviews, tables and examples illustrating the use of Ultramid® in electrical engineering can be found in the brochure “Engineering Plastics for the E/E Industry – Products, Applications, Typical Values”.



Gearbox control

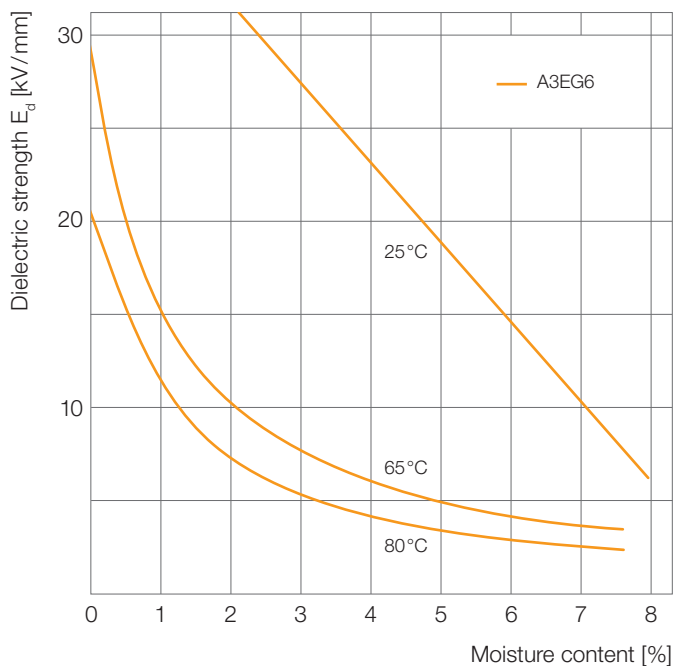

Fig. 19: Dielectric strength of Ultramid® A3EG6 at different temperatures as a function of moisture content (IEC 60243; wall thickness 3mm)

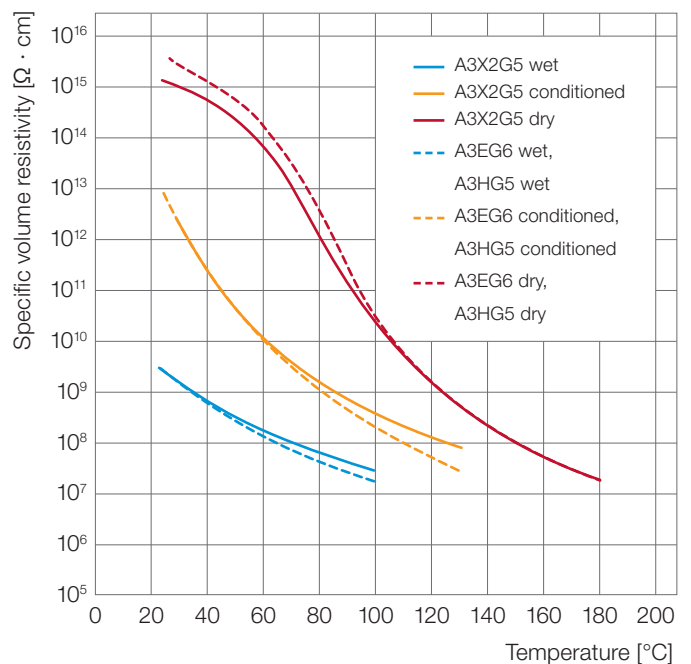

Fig. 20: Specific volume resistivity of glass-fiber reinforced Ultramid® A with different moisture contents as a function of temperature (IEC 60093)

Fire behavior

General notes

Ultramid® A, B and C gradually start to decompose at a temperature above 310 °C. In the temperature range of 450 °C to 500 °C flammable gases are given off which continue to burn after ignition. These processes are affected by many factors so that, as with all flammable solid materials, no definite flash point can be specified. The decomposition products have the odor of burnt horn. The decomposition products from charring and combustion are mainly carbon dioxide and water and depending on the supply of oxygen small amounts of carbon monoxide, nitrogen and small amounts of nitrogen-containing compounds. Toxicological studies have shown that the decomposition products formed in the temperature range up to 400 °C are less toxic than those from wood, while at higher temperatures, the toxicity is comparable.

Tests

Electrical engineering

Various material tests are carried out to assess the fire behavior of electrical insulating materials.

In Europe the incandescent wire test in accordance with IEC 60695-2-10ff is often specified (Tables 3 and 5). A further test for rod-shaped samples is the rating in accordance with “UL 94-Standard Tests for Flammability of Plastic Materials for Parts in Devices and Appliances” from the Underwriters Laboratory Inc./USA. On the basis of this test method almost all unreinforced grades fall into the UL 94V-2 class. The unreinforced, flame-retardant grade Ultramid® C3U attains the rating UL 94V-0.

Moreover, IEC 60335 requires that household appliances which operate unattended and through which high currents flow have to pass the GWIT 775 (IEC 60695-2-13).

The glass-fiber reinforced Ultramid® grades generally require a flame-retardant finish in order to achieve a correspondingly favorable classification. Examples are Ultramid® A3X2G ..., A3U40G5, B3UG4 and Ultramid® B3U30G6. The flame-retardant properties are summarized in Tables 3 and 5.

Ultramid®	UL 94	Glow wire test ¹⁾ IEC 60695 2-12	FMVSS 302 (d ≥ 1 mm)
A3K	V-2 (0.4 mm)	960 °C ²⁾	reached
B3S	V-2 (1.5 mm)	960 °C ²⁾	reached
A3EG... reinforced	HB	650 °C	reached
B3EG... reinforced	HB	650 °C	reached
A3X2G10	V-0 (1.5 mm)	960 °C	reached
A3X2G5	V-0 (0.8 mm)	960 °C	reached
A3X2G7	V-0 (0,75 mm)	960 °C	reached
B3UG4	V-2 (0.71 mm)	960 °C	reached
B3U30G6	V-2 (0.8 mm)	960 °C	reached
C3U	V-0 (0.4 mm)	960 °C	reached
T KR 4365 G5	V-0 (0.8 mm)	960 °C	reached
A3U40G5	V-0 (0.4 mm)	960 °C	reached

Table 5: Fire performance

¹⁾ Material testing conducted on sheets (thickness of 1 mm)

²⁾ Undyed; dyeing can have an influence

Transportation

In traffic and transport engineering, plastics contribute substantially to the high performance of road vehicles and trains. Materials used inside motor vehicles are governed by the fire safety requirements according to DIN 75200 and FMVSS302, which are met by most Ultramid® products with a wall thickness of 1 mm and above (Table 5). For rail vehicles, in addition to different national regulations, a European standard, EN45545, is drawn up. Among other things it also contains requirements regarding the other effects of fire such as the density and toxicity of smoke gas.

Construction industry

The testing of building materials for the construction industry is carried out in accordance with DIN 4102, Part 1, "Fire behavior of building materials and building parts". Sheets of unreinforced and glass-fiber reinforced Ultramid® (thickness ≥ 1 mm) are rated as normally flammable building materials 1) in Building Materials Class B 2 (designation in accordance with the building regulations in the Federal Republic of Germany).

Further literature

The wide variety of existing applications and sets of rules can be difficult to keep track with. More detailed information and key material figures can be obtained from the following BASF brochures:

- Engineering Plastics for the E/E Industry – Standards and Ratings
- Engineering Plastics for the E/E Industry – Products, Applications, Typical Values
- Engineering Plastics for Automotive Electrics – Products, Applications, Typical Values

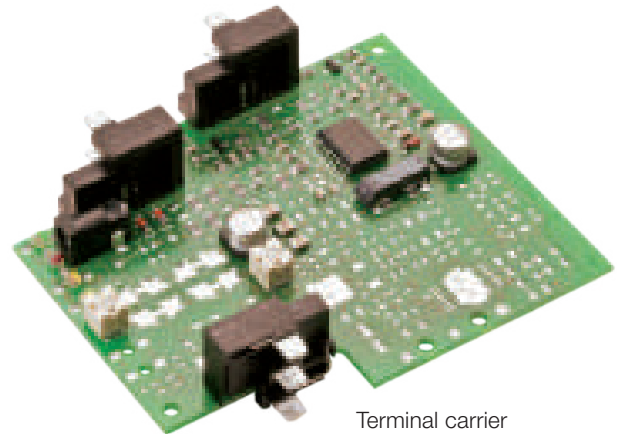

Terminal carrier



Generator end cap

Resistance to chemicals

Polyamide shows good resistance to lubricants, fuels, hydraulic fluids and coolants, refrigerants, dyes, paints, cleaners, degreasing agents, aliphatic and aromatic hydrocarbons and many other solvents even at elevated temperatures.

Ultramid® is resistant to corrosion, to aqueous solutions of many inorganic chemicals (salts, alkalis). Special mention should be made of its outstanding resistance against stress-crack formation compared to many amorphous plastics. Many media such as, for instance, wetting agents, ethereal oils, alcohols and other organic solvents do not detrimentally affect the creep behavior of polyamide.

Good resistance to chemicals is an important prerequisite for the use of Ultramid® in automotive, aerospace and chemical engineering.

Ultramid® is not resistant to concentrated mineral acids. The same applies to certain oxidants and chlorinated hydrocarbons, especially at elevated temperatures. Attention should also be paid to its sensitivity to certain heavy-metal salt solutions such as, for example, zinc chloride solution. Glass-fiber reinforced brands can also be attacked by alkaline media since the glass fibers are fundamentally not resistant to such media.

Table 6 summarizes Ultramid®'s resistance to the most important chemicals. Further information on the effects of solvents and chemicals can be found on the internet, www.plasticsportal.eu or in the brochure "Ultramid®, Ultradur® and Ultraform® – Resistance to Chemicals". The brochure gives an overview over the long term- and short-term media resistance of Ultramid® by using a lot of test results. They should give an impression of the phenomena and influencing factors that can be met when thermoplastic components are exposed to chemicals. The statements made here are of a general nature and do not claim being complete or universally valid. Only in individual cases it is possible to adequately take into account all of the relevant factors and to assess the effects.



Thermostat housing

The consequences of exposing a polymeric material to various types of media can depend on many factors that sometimes interact in a complex way. Consequently, testing a component under realistic circumstances and under typical application conditions always gives the most meaningful results on whether a material is suited for a given application or not. In contrast, when it comes to laboratory tests, simple test specimens are often exposed to a medium under well-defined and constant conditions. Such experiments allow a relative comparison between different materials and thus lay the foundation for pre-selecting potential candidates as the right material for a given application. However, these experiments cannot substitute actual-practice testing.

When clearing the use of the material, especially for components subject to high stresses and possible exposure to corrosive chemicals, its chemical suitability should be verified. This may be done on the basis of experience with similar parts made of the same material in the same medium under comparable conditions or by testing parts under practical conditions.



Oil sensor



Oil pan

	Ultramid® A	Examples	Ultramid® B
Highly resistant: empirical value from numerous applications under their typical conditions	aliphatic hydrocarbons	natural gas, fuels (Otto, diesel), paraffin oil, motor oils, technical greases and lubricants	aliphatic hydrocarbons
	aromatic hydrocarbons	benzene, toluene	aromatic hydrocarbons
	alkalis	ordinary soap, washing solutions, alkaline concrete	alkalis
	ethylene glycol	brake fluids, hydraulic fluids	
	ethers	THF, antiknock agents for fuels (TBME, ETBE)	ethers
	esters	greases, cooking oils, motor oils, surfactants	esters
	aliphatic alcohols	<60°C [<140°F] ethanol, methanol, isopropanol, anti-freeze agents for windshield washing systems, spirits, fuels (E10, E50, E90)	aliphatic alcohols
	water and aqueous solutions	drinking water, seawater, beverages	water and aqueous solutions
Somewhat resistant: known applications, thorough testing and case-to-case evaluations necessary	organic acids	in the solid state: citric acid, benzoic acid	organic acids
	oxidants	ozone as a component of air	oxidants
	alkalis	sodium hydroxide solution, ammonia solution, urea solution, amines	alkalis
	ethylene glycol	coolants	
	esters	transmission oils, biodiesel	esters
	aliphatic alcohols	>60°C [>140°F] ethanol, methanol, isopropanol, anti-freeze agents for windshield washing systems, spirits, fuels	aliphatic alcohols
	water and aqueous solutions	chlorinated drinking water	water and aqueous solutions
	organic acids	as an aqueous solution: acetic acid, citric acid, formic acid, benzoic acid	organic acids
oxidants	traces of ozone, chlorine or nitrous gases	oxidants	

Table 6: Overview of the media resistance of Ultramid® (Discoloration of the test specimens is not taken into consideration during the evaluation of the resistance)

Examples	Ultramid® S	Examples	Ultramid® T	Examples
natural gas, fuels (Otto, diesel), paraffin oil, motor oils, technical greases and lubricants	aliphatic hydrocarbons	natural gas, fuels (Otto, diesel), paraffin oil, motor oils, technical greases and lubricants	aliphatic hydrocarbons	natural gas, fuels (Otto, diesel), paraffin oil, motor oils, technical greases and lubricants
benzene, toluene	aromatic hydrocarbons	benzene, toluene	aromatic hydrocarbons	benzene, toluene
ordinary soap, washing solutions, alkaline concrete	alkalis	ordinary soap, washing solutions, alkaline concrete	alkalis	ordinary soap, washing solutions, alkaline concrete
	ethylene glycol	brake fluids, hydraulic fluids, coolants	ethylene glycol	brake fluids, hydraulic fluids
THF, antiknock agents for fuels (TBME, ETBE)	ethers	THF, antiknock agents for fuels (TBME, ETBE)	ethers	THF, antiknock agents for fuels (TBME, ETBE)
greases, cooking oils, motor oils, surfactants	esters	greases, cooking oils, motor oils, surfactants	esters	greases, cooking oils, motor oils, surfactants
<60°C [<140°F] ethanol, methanol, isopropanol, anti-freeze agents for windshield washing systems, spirits, fuels (E10, E50, E90)	aliphatic alcohols	<60°C [<140°F] ethanol, methanol, isopropanol, anti-freeze agents for windshield washing systems, spirits, fuels (E10, E50, E90)	aliphatic alcohols	<60°C [<140°F] ethanol, methanol, isopropanol, anti-freeze agents for windshield washing systems, spirits, fuels (E10, E50, E90)
drinking water, seawater, beverages	water and aqueous solutions	drinking water, seawater, beverages, road salt, calcium chloride and zinc chloride solutions	water and aqueous solutions	drinking water, seawater, beverages, road salt, calcium chloride and zinc chloride solutions
in the solid state: citric acid, benzoic acid	organic acids	in the solid state: citric acid, benzoic acid	organic acids	in the solid state: citric acid, benzoic acid
ozone as a component of air	oxidants	ozone as a component of air	oxidants	ozone as a component of air
sodium hydroxide solution, ammonia solution, urea solution, amines	alkalis	sodium hydroxide solution, ammonia solution, urea solution, amines	alkalis	sodium hydroxide solution, ammonia solution, urea solution, amines
	ethylene glycol	coolants	ethylene glycol	coolants
transmission oils, biodiesel	esters	transmission oils, biodiesel	esters	transmission oils, biodiesel
>60°C [>140°F] ethanol, methanol, isopropanol, anti-freeze agents for windshield washing systems, spirits, fuels	aliphatic alcohols	>60°C [>140°F] ethanol, methanol, isopropanol, anti-freeze agents for windshield washing systems, spirits, fuels	aliphatic alcohols	>60°C [>140°F] ethanol, methanol, isopropanol, anti-freeze agents for windshield washing systems, spirits, fuels
chlorinated drinking water	water and aqueous solutions	chlorinated drinking water	water and aqueous solutions	chlorinated drinking water
as an aqueous solution: acetic acid, citric acid, formic acid, benzoic acid	organic acids	as an aqueous solution: acetic acid, citric acid, formic acid, benzoic acid	organic acids	as an aqueous solution: acetic acid, citric acid, formic acid, benzoic acid
traces of ozone, chlorine or nitrous gases	oxidants	traces of ozone, chlorine or nitrous gases	oxidants	traces of ozone, chlorine or nitrous gases

	Ultramid® A	Examples	Ultramid® B
Not resistant	mineral acids	concentrated hydrochloric acid, battery acid, sulfuric acid, nitric acid	mineral acids
	oxidants	halogens, oleum, hydrogen peroxide, ozone, hypochlorite	oxidants
Triggers stress cracking	aqueous calcium chloride solutions	road salt	aqueous calcium chloride solutions
	aqueous zinc chloride solutions	road salt solution in contact with zinc-plated components	aqueous zinc chloride solutions
Solvents		concentrated sulfuric acid	
		formic acid 90%	
		hexafluoroisopropanol (HFIP)	

Table 6: Overview of the media resistance of Ultramid® (Discoloration of the test specimens is not taken into consideration during the evaluation of the resistance)



Examples	Ultramid® S	Examples	Ultramid® T	Examples
concentrated hydrochloric acid, battery acid, sulfuric acid, nitric acid	mineral acids	concentrated hydrochloric acid, battery acid, sulfuric acid, nitric acid	mineral acids	concentrated hydrochloric acid, battery acid, sulfuric acid, nitric acid
halogens, oleum, hydrogen peroxide, ozone, hypochlorite	oxidants	halogens, oleum, hydrogen peroxide, ozone, hypochlorite	oxidants	halogens, oleum, hydrogen peroxide, ozone, hypochlorite
road salt				
road salt solution in contact with zinc-plated components				
concentrated sulfuric acid		concentrated sulfuric acid		concentrated sulfuric acid
formic acid 90%		formic acid 90%		formic acid 90%
hexafluoroisopropanol (HFIP)		hexafluoroisopropanol (HFIP)		hexafluoroisopropanol (HFIP)



Oil filter module

Behavior on exposure to weather

Ultramid® is suitable for outdoor applications. Different grades come into consideration depending on requirements.

The unreinforced, stabilized grades with K as identifier are highly resistant to weathering even when unpigmented. Suitable pigmentation increases outdoor performance still further, best results being achieved with carbon black.

The reinforced grades also exhibit good resistance to weathering. Stabilized grades, e. g. Ultramid® B3WG6 bk564, can be relied upon to last for well over ten years.

However, owing to the glass fibers, the surface is attacked to a greater extent than with unreinforced Ultramid®, which means that the quality of the surface and its color can change after just a short period of outside weathering and turn gray. In the case of colored grades, the level of resistance is essentially dependent on the pigments that are used. Due to the large number of possible coloring components, it is necessary to confirm the level of resistance in each individual case. For outdoor applications, e. g. mirror housings of motor vehicles, whose surface quality must not change even after many years of use, grades with special UV stabilization and products with a high carbon black content have proven successful.

After several years of weathering, removal of the surface layer down to a few micrometers is to be expected. However, experience shows that this does not have any obvious adverse effect on the mechanical properties. This is illustrated by results from outdoor weathering tests conducted over ten years which indicate only a slight drop in the key mechanical figures (Fig. 21).

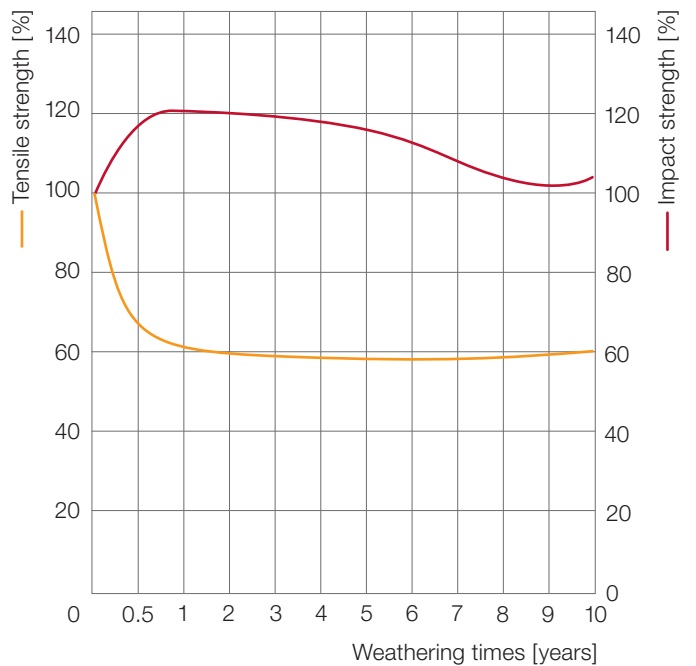

Fig. 21: Change in values for Ultramid® B3WG6 black 564 after outdoor exposure to weather



Fixing clip for photovoltaic modules

Ultramid® T

The partially aromatic polyamide Ultramid® T has outstanding properties:

- dimensional stability even at higher temperatures (melting point: 295 °C)
- excellent rigidity and strength
- mechanical properties uncompromised by external conditions
- toughest of all partially aromatic polyamides
- low shrinkage and warpage
- slow water absorption
- good chemical resistance
- excellent electrical properties

In particular the highly glass fiber-filled grades are suitable as an ideal substitute for metal due to their high mechanical resilience and their ease of processing. In contrast to most other PPA materials, Ultramid® T offers a wide process window. This makes it possible to manufacture components by injection molding using conventional water-cooled molds. Ultramid® T is therefore especially user-friendly.

Mechanical properties

In comparison to conventional polyamides (e. g. PA6 or PA66), Ultramid® T is noted for its much slower water absorption. Furthermore, moisture absorption does not result in any significant change to the mechanical properties at room temperature.

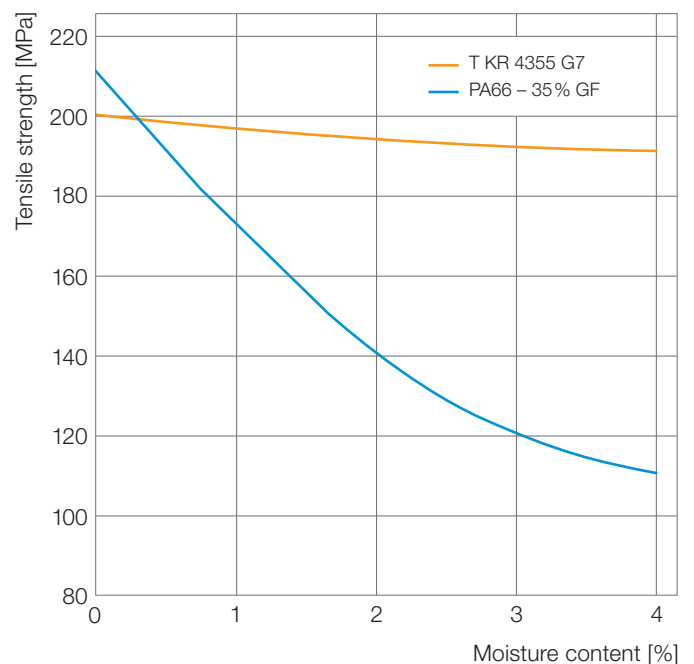

Fig. 22: Tensile strength of Ultramid® T compared to PA66 at 23 °C, different moisture contents



In general, partially aromatic polyamides are not considered to be tough materials. However, the unique molecular structure of Ultramid® T results in significantly higher toughness values compared to other partially aromatic polyamides. Due to its excellent toughness in cold environments and in dry state, Ultramid® T is ideally suited, e.g. as material for plugs and connectors.

Chemical resistance

Like all polyamides, Ultramid® T also shows excellent chemical resistance. In addition, the material offers a number of other advantages, for instance resistance to polar substances such as alcohols, aqueous calcium and zinc chloride solutions. Moreover, the strength and rigidity reduction and the change in volume are much lower with Ultramid® T than with a PA6.

Shrinkage and warpage

Products based on Ultramid® T show lower shrinkage in the longitudinal and transverse direction in comparison to PA66. Depending on the component geometry, this leads to extremely low warpage. In addition, as a result of the slow water absorption compared with standard polyamides, components made from Ultramid® T have significantly higher dimensional stability under different external conditions.

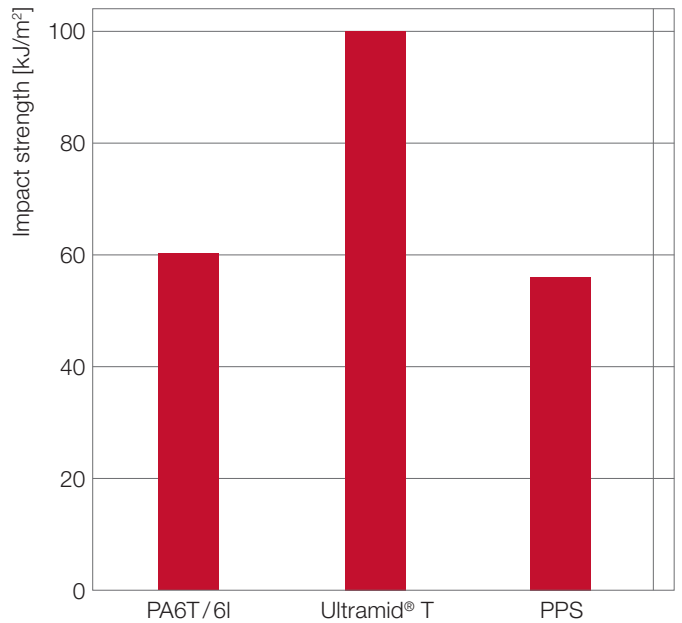

Fig. 23: Impact strength (23°C) of Ultramid® T compared to PA6T/6I and PPS (glass fiber content: 30-35%)



Fuel pressure sensor

Ultramid® S Balance

As a long-chain polyamide, Ultramid® S Balance is noted primarily for the following properties:

- good hydrolysis resistance
- high stress cracking resistance
- low water absorption, high dimensional stability
- mechanical properties largely independent of the level of conditioning

Among long-chain polyamides, Ultramid® S Balance has one of the highest levels of rigidity and strength. This makes it the material of choice in areas which require a combination of the resistance to media of long-chain polyamides and the mechanical properties of the conventional materials PA6 and PA66.

Mechanical properties

The lower water absorption of Ultramid® S Balance compared to PA6 or PA66 results in constant mechanical properties under changing climatic conditions. Furthermore, Ultramid® S Balance has a higher heat aging resistance than PA12 and thus offers a balanced range of properties for a variety of applications.

Chemical and hydrolysis resistance

Like all polyamides, Ultramid® S Balance shows excellent chemical resistance. In addition, this material also offers a number of other advantages, e.g. increased hydrolysis resistance compared with PA6 or PA66. This makes Ultramid® S Balance the perfect material for plug-in connectors, pipes and vessels in cooling circuits. The material can also be used in fuel applications, such as quick-action couplings of fuel lines.

Stress cracking resistance due to the presence of zinc chloride is an important criterion for car exteriors. Due to their inherent molecular structure, long-chain polyamides have a clear advantage. For instance, glass-fiber reinforced Ultramid® S Balance meets the conditions of the standards SAE 2644 and FMVSS 106. This means that the material is particularly suited to the overmolding of metal and electronic components that come into contact with aggressive media, e.g. wheel speed sensors.



Abb. 24: Hydrolysis resistance of Ultramid® S Balance compared with PA66, in Glycantin/water (1:1) at 130°C



The processing of Ultramid®

Processing characteristics

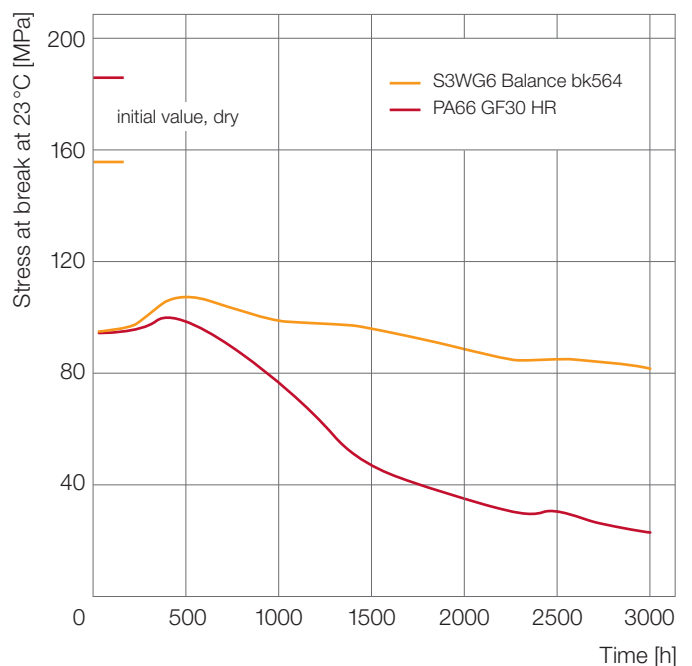
Ultramid® can be processed by all methods known for thermoplastics. The main methods which come into consideration are injection molding and extrusion. Complex moldings are economically manufactured in large numbers from Ultramid® by injection molding. The extrusion method is used to produce films, semi-finished products, pipes, profiled parts, sheet and monofilaments. Semi-finished products are usually further processed by cutting tools to form finished molded parts.

The following text examines various topics relating to the injection molding of Ultramid®. Further general and specific information can be found on the internet at www.plasticsportal.eu or the Ultra-Infopoint (ultraplaste.infopoint@basf.com). More details on the injection molding of individual products are given in the respective processing data sheets.

Melting and setting behavior

The softening behavior of Ultramid® on heating is shown by the shear modulus and damping values measured in accordance with ISO 6721-2 as a function of temperature (Figs. 5 and 6). Pronounced softening only occurs just below the melting point. Glass fibers raise the softening point. A measure commonly used to determine the softening temperature is the heat deflection temperature HDT in accordance with ISO 75.

The melt also solidifies within a narrow temperature range which is about 20°C to 40°C below the melting point depending on the rate of cooling and the Ultramid® grade in question. At the same time there is a contraction in volume of 3% to about 15%. The total volumetric shrinkage can be seen by the PVT diagrams in Fig. 25.

The crystallization and PVT behavior can also be found in the material data of programs for injection molding simulation.

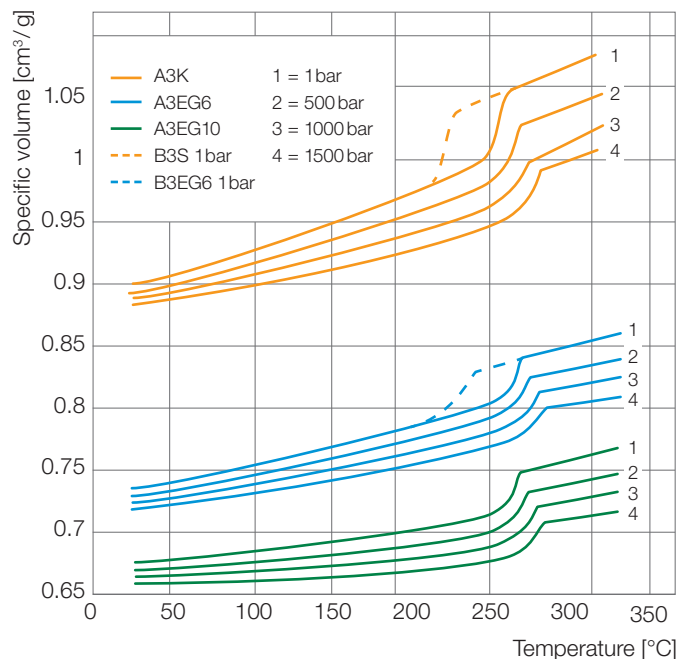

Fig. 25: PVT diagrams for Ultramid® A and B

Thermal properties

The relatively high specific enthalpy of Ultramid® requires powerful heating elements. The setting and cooling times increase by the square of the wall thickness, which is why wall thickness clusters should be avoided to ensure cost-efficient production.

Melt viscosity

The rheological properties of Ultramid® melts are evaluated on the basis of viscosity diagrams obtained from measurements using a capillary rheometer or on the basis of injection molding tests.

In the processing temperature range the Ultramid® grades have a melt viscosity of 10 to 1,000 Pa·s (Figs. 26 and 27), the actual value being highly dependent on temperature and shear rate. The higher the relative molar mass or the relative solution viscosity (given by the first digit in the nomenclature), the higher is the melt viscosity and the greater the resistance to flow (Fig. 26). In the case of Ultramid® grades with mineral fillings or glass-fiber reinforcement the viscosity increases in proportion to the amount of reinforcing material incorporated (Fig. 27).

The melt viscosity can change over time. A rapid drop in viscosity can occur for example when the melt is too moist, too hot or subjected to high mechanical shear forces. Oxidation can also cause the viscosity to fall. All these factors have an effect on mechanical properties and the heating aging resistance of the finished parts or the semi-finished products.

Thermostability of the melts

When correctly processed the thermostability of Ultramid® melts is outstanding. Under normal processing conditions the material is not attacked or modified. Degradation in the polymer chains only occurs when the residence time is relatively long. The recommended melt temperatures for processing may be found in Table 7 and in the Ultramid® product range.

If the melt does not come into contact with oxygen, no noteworthy color changes occur. Upon exposure to air, for example, when open injection nozzles are used or in case of interruptions in production, the surface can already become discolored after a brief time.

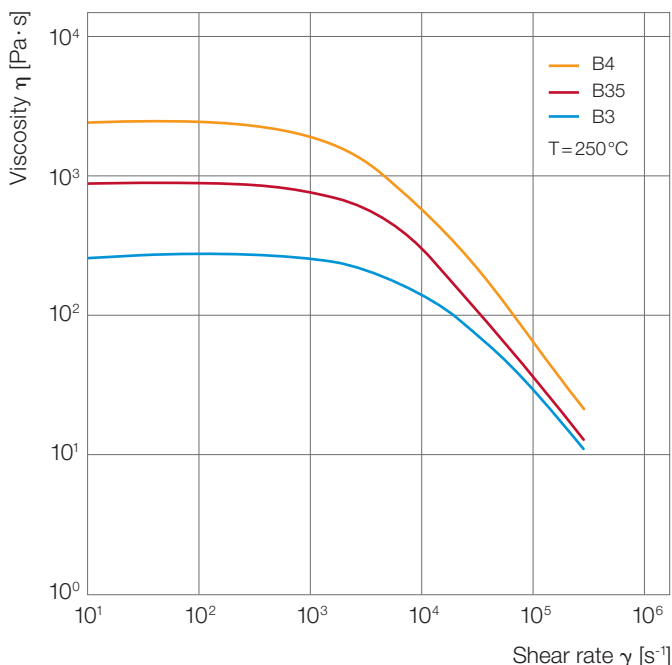

Fig. 26: Apparent viscosity of Ultramid® B (unreinforced) as a function of shear rate

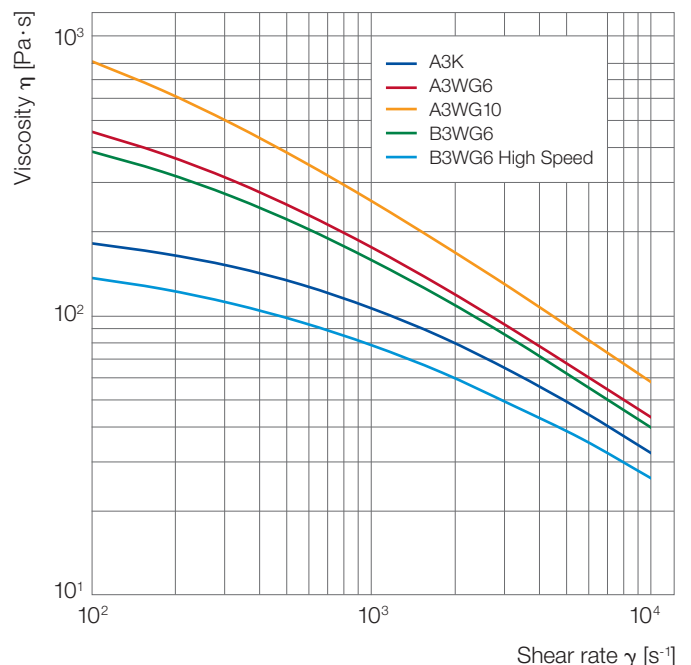

Fig. 27: Apparent viscosity of Ultramid® A and B with different glass fiber contents, T = 280°C

General notes on processing

Preliminary treatment, drying

Ultramid® must be processed dry. If the moisture content is too high, this can result in losses of quality. They may affect the quality of the molded part surface. A loss in mechanical properties, e.g. resulting from polymer degradation, is also possible. With the flame-retardant grades, plate-out can increasingly form.

The maximum permissible moisture content for processing by injection molding is 0.15%; for extrusion it is 0.1%. Detailed recommendations can be found in the processing data sheets. In the case of Ultramid® T, the moisture content should be at a much lower level of $\leq 0.03\%$. The granules supplied in moisture-proof packaging can be processed without any special preliminary treatment. However, if the containers have been stored open or damaged, drying is advisable or may be required.

In order to prevent the formation of condensation, containers which are stored in non-heated rooms may only be opened once they have reached the temperature in the processing room.

The drying time – usually from 4 to 8 hours – is dependent on the moisture content and product. Among the different dryer systems, dehumidifying dryers are the most efficient and reliable. The optimum drying temperatures for Ultramid® are approx. 80°C to 120°C. As a general rule, the specifications of the equipment manufacturer should be followed. The use of vented screws for releasing the moisture as part of the injection molding process is not advisable.

Pale granules and thermally sensitive colors should be dried under mild conditions at granule temperatures not exceeding 80°C in order to avoid a change in color hues. By contrast, temperatures of up to 120°C do not influence the mechanical properties of the moldings.

Self-coloring

Self-coloring of Ultramid® by the converter is generally possible. In the case of Ultramid® T, which is usually processed at temperatures above 310°C, the thermostability of the color additive is to be considered.

The properties of parts made from in-plant colored pellets, especially homogeneity, impact strength, fire and shrinkage characteristics, have to be checked carefully because they can be dramatically altered by the additives and the processing conditions in question.

Ultramid® grades that are UL94-rated must adhere to the stipulations of UL 746D if the UL rating is to be retained. Only PA-based color batches that are HB-rated or higher may be used for the self-coloring of UL 94 HB-rated Ultramid® grades. Ultramid® grades that are UL 94 V-2, V-1 or V-0 rated may only be dyed with UL-approved color batches (special approval required).

If self-colored parts are used in food applications special provisions have to be observed (see “Food legislation”).

Reprocessing, recycling of ground material

Ground sprue material, reject parts and the like from the processing of Ultramid® can be reused to a limited extent, provided they are not contaminated. It should be noted that the ground material is particularly hygroscopic, and so it should generally be dried before being processed. Repeated processing can cause damage.

In specific cases, it may be helpful to check the solution viscosity or the melt viscosity. It must be checked in advance whether the addition of regenerated material is permitted in the respective application. With flame-retardant products, restrictions on the permitted amount of regenerated material (e.g. UL specifications) must also be noted.

As Ultramid® is not homogeneously mixable with most other thermoplastics, including PS, ABS, and PP, only single-variety mixtures of new product and regenerated material may be processed. Even small amounts of such “extraneous material” usually have a negative effect which becomes apparent, for example, as laminar structures – especially close to the gate – or in a reduced impact strength.

Machine and mold technique for injection molding

Ultramid® can be processed on all commercial injection molding machines.

Plasticizing unit

The single-flighted three-section screws usual for other engineering thermoplastics are also suitable for the injection molding of Ultramid®. In modern machines the effective screw length is $20-23 \cdot D$ and the pitch $1.0 \cdot D$. The geometry of the three-section screw which has long proved effective is shown in Fig. 28.

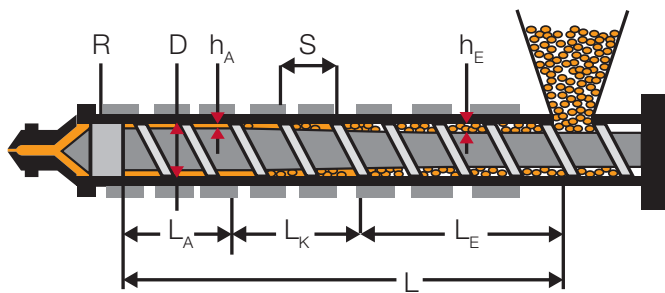

D	outer diameter of the screw	
L	effective screw length	20-23 D
L _E	length of the feed section	0.5-0.55 L
L _K	length of the compression section	0.25-0.3 L
L _A	length of the metering section	0.2 L
h _A	flight depth in the metering section	
h _E	flight depth in the feed section	
S	pitch	1.0 D
R	non-return valve	

Fig. 28: Screw geometry – terms and dimensions for three-section screws for injection-molding machines

Recommended flight depths are shown in Fig. 29. These flight depths apply to standard and more shallow-flighted screws and afford a compression ratio of about 1 to 2. Shallow-flighted screws convey less material than deep-flighted ones. The residence time of the melt in the cylinder is therefore shorter. This means that more gentle plasticization of the granules and greater homogeneity of the melt can be an advantage for the quality of injection-molded parts.

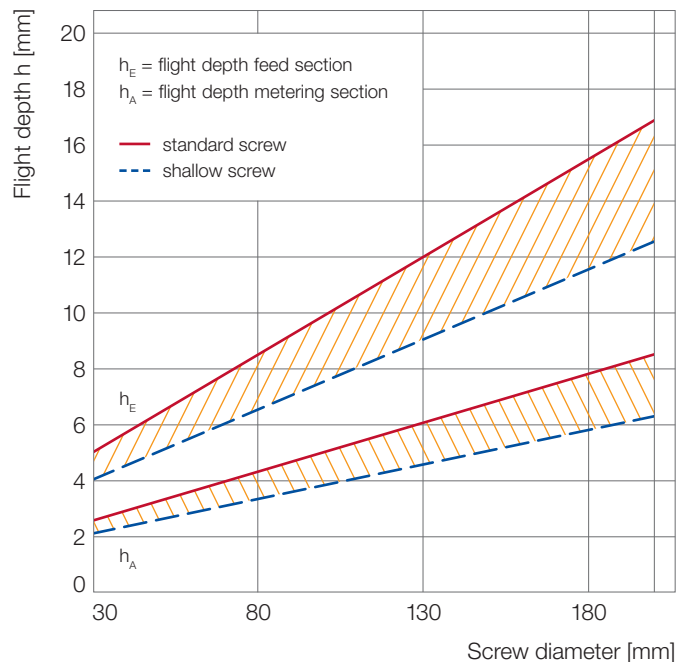

Fig. 29: Screw flight depths for three-section screws in injection-molding machines

In order to ensure that moldings can be manufactured in a reproducible way, it is important to have a non-return valve which is designed to favor a good flow and closes well. This allows a constant melt cushion and a sufficient holding pressure time to be achieved. The clearance between the cylinder and the valve ring should be no more than 0.02mm.

Due to the low shear stress of the melt, open nozzles are generally used for the injection molding of Ultramid®. They are also advantageous when materials have to be changed comparatively quickly. If the plasticizing unit is vertical and/or the melt viscosity is low, often nothing will prevent the escape of molten polymer from the nozzle. In these cases, shut-off nozzles are recommended to ensure uninterrupted production.

The machine nozzle should be easy to heat and have an additional heater band for this purpose if necessary. So it is possible to prevent undesired freezing of the melt. When processing most glass-fiber reinforced thermoplastics, it is also advisable with glass-fiber reinforced Ultramid® to use hard-wearing plasticizing units. With flame-retardant grades, the use of corrosion-resistant steels may be necessary.

Injection mold

The design rules for injection molds and gating systems which are specified in the relevant literature also apply to moldings made from Ultramid®.

Filling simulations at an early stage can make an important contribution to the design, especially where molded parts have complex geometries.

Molded parts made of Ultramid® are easy to demold. The draft on injection molds for Ultramid® is generally 1 to 2 degrees. With drafts of a lower angle, the demolding forces increase greatly, which means that more attention has to be paid to the ejector system.

In principle, Ultramid® is suitable for all usual types of gate. When hot runner nozzles are used, it should be possible to regulate them individually. Heated components must have a homogeneous temperature level.



Exterior mirror base

Gates must be sufficiently large in size. Gate cross sections which are too small can cause a wide range of problems. These include material damage resulting from excessively high shear stress or insufficiently filled molded parts as a result of pressure losses. Premature freezing of the melt before the end of the holding pressure time can cause voids and sink marks.

In the case of fiber-reinforced grades, increased wear occurs in the gate area at relatively high output rates; this can be countered by selecting suitable types of steel and using interchangeable mold inserts. Corrosion-resistant, high-alloy steels (for example X42Cr13, DIN 1.2083) have proven suitable for processing flame-retardant products.

When the melt is injected, the air in the mold cavity must be able to escape easily – especially at the end of the flow path or at places where flow fronts meet – so that scorch marks from compressed air are not produced (diesel effect). This applies particularly to the processing of flame-retardant grades. Figure 30 illustrates how mold vents can be realized.

The quality of moldings is very highly dependent on the temperature conditions in the mold. A precise and effective mold temperature control is possible only with a well-designed system of temperature control channels in the mold together with temperature control devices of appropriate power. The mold temperatures required for Ultramid® can be achieved with temperature control devices using water, with system pressure being superimposed in a controlled way if necessary.

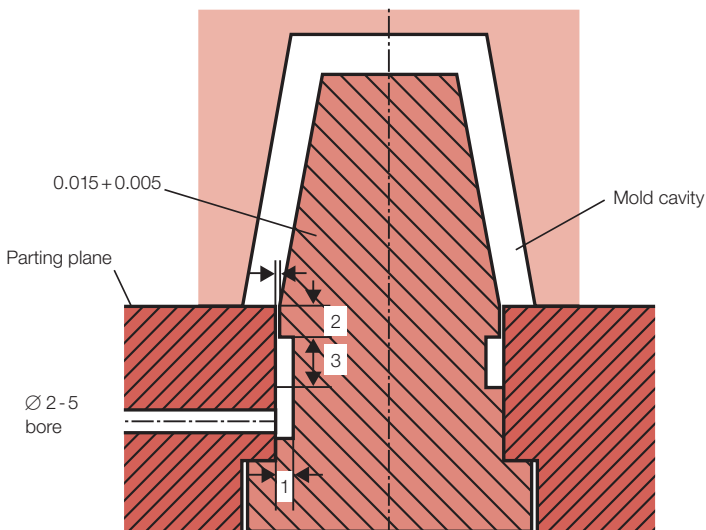
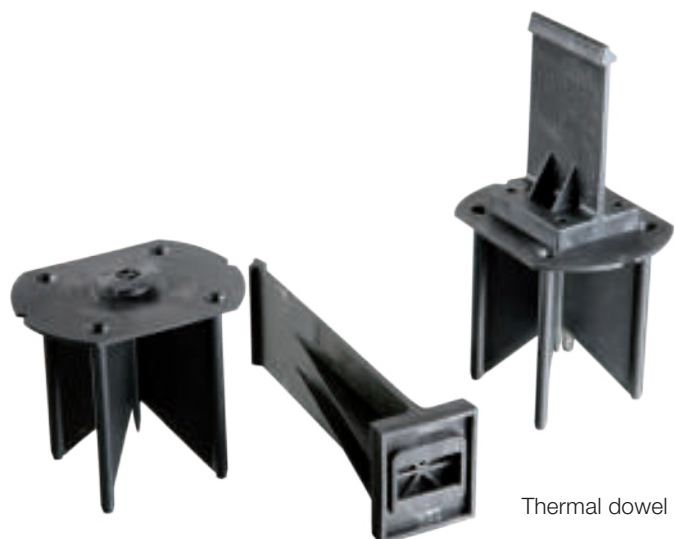

Fig. 30: Design diagram for mold venting (all size in mm)



Injection molding

The processing machine is started up in the usual manner for thermoplastics: cylinder and nozzle heaters are set to achieve the melt temperature required in each case (Table 7 gives guideline values). As a precaution, the melt exposed to thermal stresses during the heating-up phase is pumped off. After this the optimum processing conditions have to be determined in trials.

When processing flame-retardant grades, it is recommended that the melt should not be pumped off but rather injected into the mold. If pumping off cannot be avoided, an extraction device (hood) should be available and the melt cooled in the water bath (see “Safety notes – Safety precautions during processing”).

The residence time of the plastic in the plasticizing cylinder is a major factor determining the quality of the molding. Residence times which are too short can result in thermal inhomogeneities in the melt whereas, if they are too long (> 10 min), they often result in heat damage.

Melt temperature

The correct melt temperature within the specified ranges (Table 7) is dependent on the length of melt flow path and the thickness of the walls of the molding. Higher melt temperatures should be avoided due to the possibility of heat damage to the melt. Slight increases (+10°C) are only permissible for extremely short production cycles or residence times of the melt in the cylinder.

When the melt has a long residence time in the cylinder, gentle fusion is achieved by setting the temperatures of the cylinder heater bands so that they rise from the charging hopper toward the nozzle. In the case of short residence times, flat temperature control on the cylinder is sensible (Fig. 31).

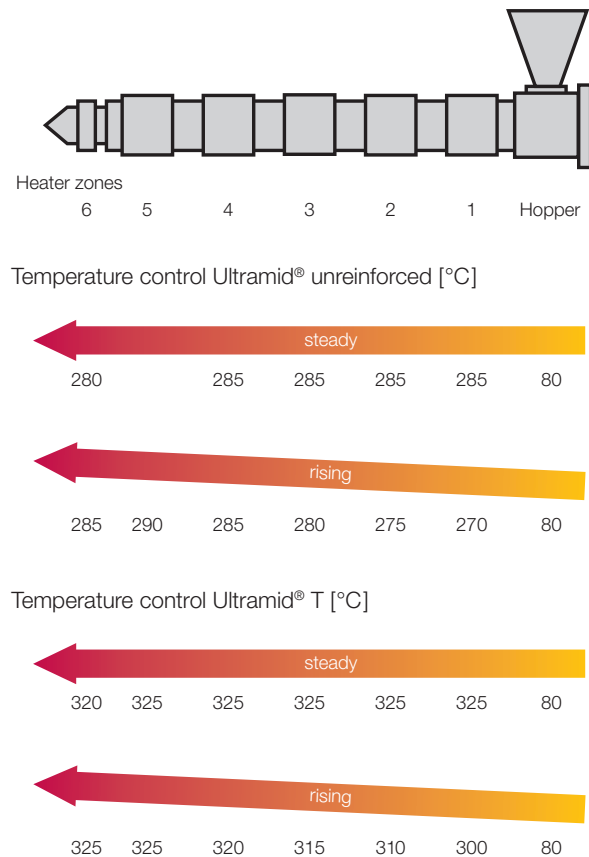

Fig. 31: Examples of cylinder temperature control

Mold temperatures

Unreinforced Ultramid® is processed as a rule at mold temperatures of 40 °C to 80 °C. Reinforced Ultramid® grades require higher temperatures. In order to achieve good surface qualities and moldings meeting high requirements for hardness and strength, the surface temperatures of the mold cavities should be 80 °C to 90 °C, and in special cases 120 °C to 140 °C (Table 7).

Screw speed

If possible, the screw speed should be set so as to fully utilize the time available for plasticizing within the molding cycle. For instance, a speed of 75 to 115 min⁻¹ (corresponding to a peripheral screw speed of 0.2 to 0.3 m/s) is often adequate for a 50 mm diameter screw. Too high screw speeds lead to temperature rises due to frictional heating.

Ultramid®	Melt temperature range [°C]	Mold temp. range [°C]	Melt temp. [°C]	Molding shrinkage [%]			
				Mold temp. [°C]	Testbox ¹⁾	Sheet ²⁾	
						crosswise	lengthwise
A3K, A3W	280-300	60-80	290	60	0.85	1.40	1.70
A3HG5, A3EG5, A3WG5	280-300	80-90	290	80	0.55	0.50	1.10
A3X2G5	280-300	60-90	290	80	0.50	0.50	1.25
A3EG6, A3WG6	280-300	80-90	290	80	0.55	0.40	1.05
A3X2G7	280-300	80-90	290	80	0.45	0.35	1.15
A3EG10, A3WG10	290-310	80-90	300	80	0.45	0.35	0.80
A3U40G5	280-300	80-90	290	80	0.50	0.40	1.10
B3S	250-270	40-60	260	60	0.55	0.90	1.00
B3ZG3	270-290	80-90	280	80	0.50	0.60	0.70
B3ZG6	270-290	80-90	280	80	0.40	0.30	0.70
B3EG6, B3WG6	270-290	80-90	280	80	0.40	0.25	0.75
B3WG6 High Speed	260-290	80-90	280	80	0.50	0.25	0.75
B3WG7	270-290	80-90	280	80	0.35	0.25	0.75
B3WG10	280-300	80-90	300	80	0.30	0.20	0.70
Structure B3WG10 LF	280-305	80-100	305	80		0.30	0.50
B3WGM24 HP	270-290	80-90	280	80	0.40	0.40	0.60
B3U30G6	250-275	80-90	270	80	0.50	0.40	0.90
C3U	250-270	60-80	270	60	0.80	1.25	1.30
S3WG6 Balance	270-290	80-90	270	80	0.40	0.40	0.90
T KR 4350	310-330	70-100	315	90	0.60	0.90	1.10
T KR 4355 G5	310-330	80-120	320	100	0.40	0.50	0.90
T KR 4355 G7	310-330	80-120	320	100	0.35	0.30	0.90
T KR 4355G 10	310-330	80-120	320	100	0.30	0.20	0.70
T KR 4357 G6	310-330	80-120	320	100	0.35	0.40	1.00
T KR 4365 G5	310-330	80-120	320	100	0.40	0.30	0.80

Table 7: Typical values for the process temperature and molding shrinkage

¹⁾ Impeded shrinkage, lengthwise, see Fig. 33: distance A, test box: P_N = 800 bar, wall thickness 1.5 mm

²⁾ Free shrinkage acc. to ISO 294-4, sheet: P_N = 500 bar, wall thickness 2 mm

P_N = holding pressure

Injection rate

The rate at which the mold is filled affects the quality of the moldings. Rapid injection leads to uniform setting and the quality of the surface, especially in the case of parts made from glass-fiber reinforced Ultramid®. However, in the case of moldings with very thick walls, a reduced injection rate may be appropriate in order to avoid a free jet.

Holding pressure

In order to prevent sink marks and voids, the holding pressure and the holding pressure time must be chosen to be sufficiently high so that the contraction in volume which occurs when the melt cools is largely compensated for.

Flow behavior

The flow behavior of plastic melts can be assessed in practical terms through what is known as the spiral test using spiral molds on commercial injection molding machines. The flow path covered by the melt – the length of the spiral – is a measure of the flowability of the processed material.

The spiral flow lengths for some Ultramid® grades are presented in Table 8. Via the ratio of flow path to wall thickness the flow behavior of thermoplasts can be compared. These ratios (i) are given in Table 8 for spirals 1.0, 1.5 and 2.0 mm thick. The advantage of flow-optimized Ultramid® High Speed can easily be seen. With the processing conditions, essentially the melt temperature, the flow paths can be influenced, partly between 100 and 150 mm.

Ultramid®	Temperature		Flow characteristics					
	T _M °C	T _w °C	Spiral length (mm)		Spiral length/spiral thickness (i)			
			1.0 mm	(i)	1.5 mm	(i)	2.0 mm	(i)
A3K	290	60	200	200	385	257	640	320
A3X2G5	300	80	145	145	300	200	430	215
A3EG7	290	80	130	130	245	163	400	200
A3X2G7	290	80	105	105	180	120	295	148
A3U40G5	300	80	160	160	270	180	365	183
B3S	260	80	170	170	305	203	520	260
B3U30G6	270	80	230	230	380	253	645	323
B3WG3	280	80	170	170	290	193	490	245
B3WG6	280	80	140	140	245	163	405	203
B3WG6 High Speed	280	80	200	200	375	250	605	303
B3WG10	300	100	150	150	265	177	410	205
Structure B3WG10 LF	300	100	165	165	350	233	455	228
S3WG6 Balance	290	80	150	150	280	185	335	168
T KR 4350	330	90	170	170	295	197	400	200
T KR 4355G5	330	100	145	145	215	143	350	175
T KR 4355G7	330	100	125	125	200	133	325	163
T KR 4357G6	330	100	130	130	210	140	330	165
T KR 4365G5	330	100	100	100	165	110	265	133

Table 8: Flow characteristic of Ultramid® during injection molding: spiral length and flow path/wall thickness ratio (i)

T_M = Melt temperature, T_w = Surface temperature of mold cavity

Shrinkage and aftershrinkage

ISO 294-4 defines the terms and test methods for shrinkage in processing. According to this, shrinkage is defined as the difference in the dimensions of the mold and those of the injection-molded part at room temperature. It results from the volumetric contraction of the molding compound in the injection mold due to cooling, change in the state of aggregation and crystallization. It is also influenced by the geometry (free or impeded shrinkage), and the wall thickness of the molding (Fig. 32). In addition the position and size of the gate and the processing parameters (melt and mold temperature, holding pressure and holding pressure time together with the storage time and storage temperature play a decisive role. The interaction of these various factors makes exact prediction of shrinkage difficult.

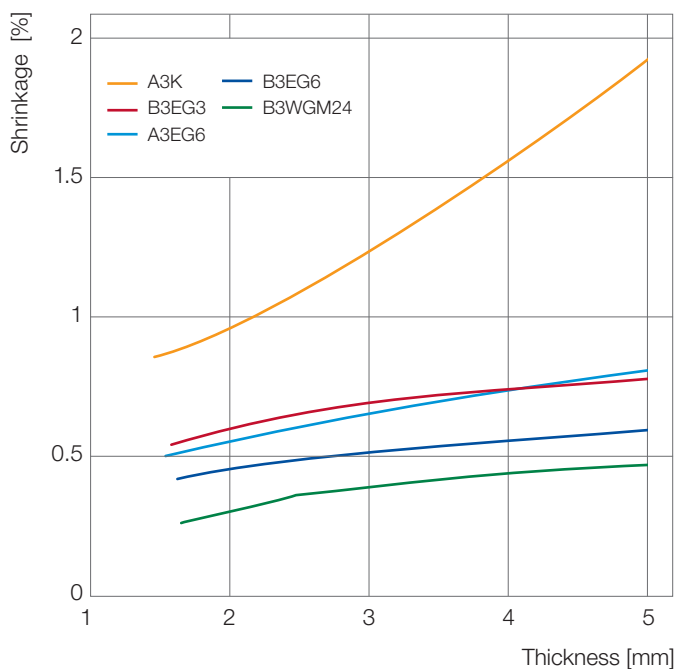

Fig. 32: Impeded shrinkage of Ultramid® as a function of the wall thickness of a test box ($P_{\text{holding pressure}} = 600 \text{ bar}$)

A useful resource for the designer are the shrinkage values determined on a test box measuring $60 \text{ mm} \cdot 60 \text{ mm}$, which is molded via a film gate, for it shows the minimum and maximum shrinkage due to the high orientation of the fibers and thus the shrinkage differences in flow direction. The value measured on the test box (Fig. 33) can serve as a guideline for an average shrinkage that occurs in a real component as the flow fronts tend to run concentrically from the gate pin here (Table 7).

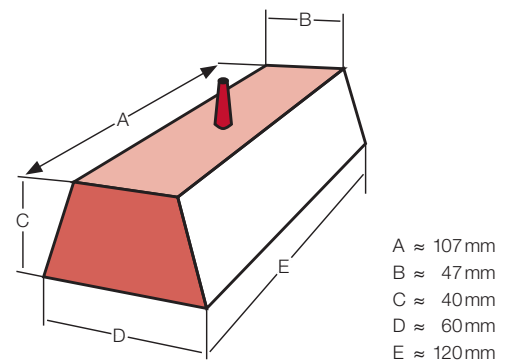

Fig. 33: Test box

As a basic rule, unreinforced polyamides shrink to a greater extent than reinforced grades. Tailored modification of the process parameters can influence dimensional tolerances for unreinforced products. The melt and mold temperatures as well as the holding pressure level and holding pressure time must be mentioned here. By contrast, with reinforced Ultramid® the influences of injection molding are only limited. Figures 34, 35 and 36 show shrinkage values for reinforced and unreinforced Ultramid® with different processing parameters.

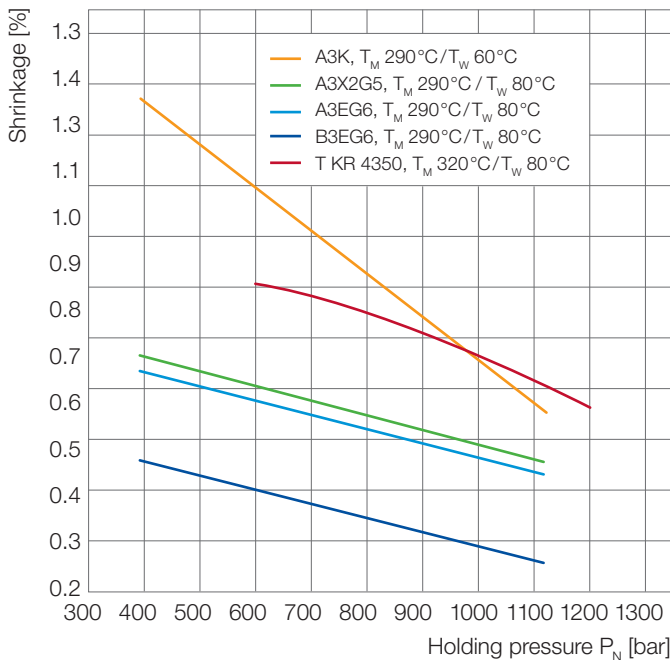

Fig. 34: Shrinkage of Ultramid® A, B and T as a function of holding pressure (test box, 1.5 mm thick)

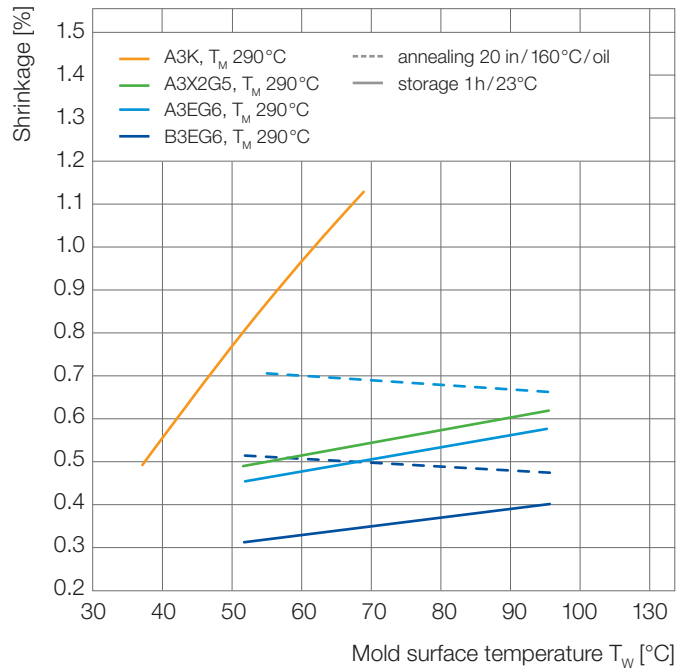

Fig. 35: Shrinkage of Ultramid® A and B as a function of mold surface temperature and annealing (test box, 1.5 mm thick)

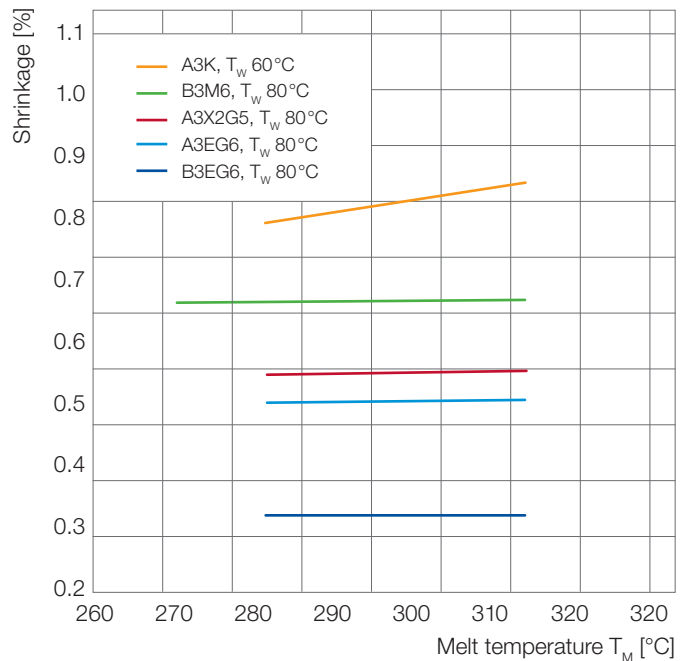

Fig. 36: Shrinkage of Ultramid® A and B as a function of melt temperature (test box, 1.5 mm thick)

Moldings of glass-fiber reinforced products show a marked difference in the shrinkage perpendicular and parallel to the direction of flow (shrinkage anisotropy). This is the result of the typical orientation of the glass fibers longitudinally to the direction of flow (Fig. 37).

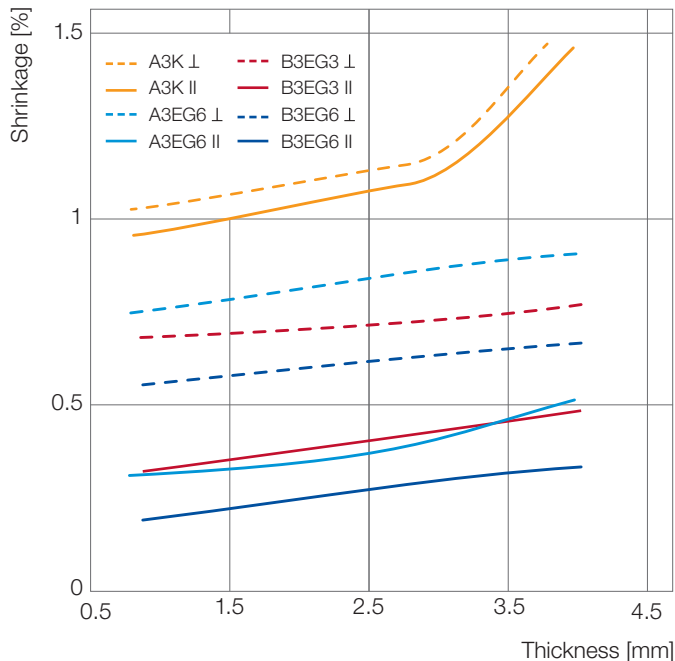

Fig. 37: Impeded shrinkage of different Ultramid® grades as a function of wall thickness (sheet measuring 110 x 110 mm made using a film gate; $P_N=500$ bar; ⊥ means perpendicular and II means parallel to the melt flow direction)

Post-shrinkage means that the dimensions of the moldings may change slightly over time because internal stresses and orientations are broken down and post-crystallization can take place depending on time and temperature. Whereas the post-crystallization is comparatively low at room temperature, at higher temperatures it can result in a possibly significant dimensional change. The process of post-shrinkage can be accelerated by annealing. High mold temperatures reduce the level of post-shrinkage and can therefore replace a subsequent annealing process (Fig. 35).

Warpage

Warpage in a molding is mainly brought about by differences in shrinkage in the melt flow direction and in the direction transverse to it. That is why molds made of glass-fiber reinforced materials tend more to warp than those made of unreinforced products. In addition it depends on the shape of the moldings, the distribution of wall thicknesses and on the processing conditions.

In the case of unreinforced grades differential temperature control of individual parts of the mold (core and cavity plate) can allow the production of warp-free or low-warpage moldings. Thus for example inward warping of housing walls can be counteracted by means of low core and high cavity plate temperatures.

The mineral, and glass beads-filled grades are distinguished by largely isotropic shrinkage. They are therefore preferred materials for warp-free moldings.

Transmission cross beam

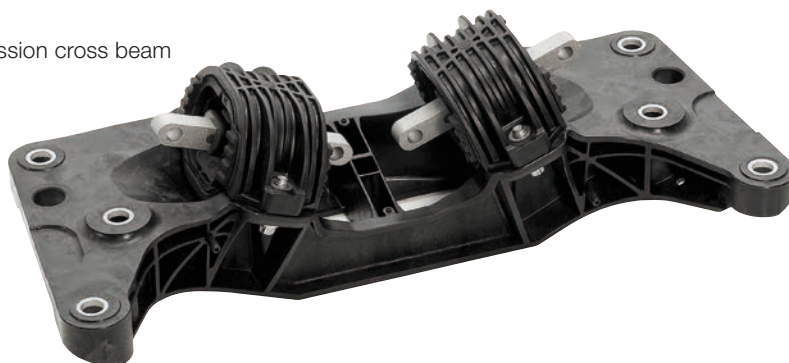

Special methods

Multi-component technology

The combination of several materials in one molding has become firmly established in injection molding technology. Various Ultramid® grades are used here, depending on what component properties are required. The components must be matched to one another in respect of their processing and material properties. A lot of experience exists in relation to the way that different materials adhere to Ultramid®. Information can be obtained from the technical information "Hard/soft compounds in injection molding technology".

Injection molding with fluid injection technology (FIT)

Fluid injection technology offers opportunities that are interesting from a technological and economic point of view for producing complex, (partially) thick-walled molded parts with cavities and functions that can be integrated. Typical FIT components made of Ultramid® are media lines in automobiles, handles, brackets and chairs.

After the plastic has been injected, the parts which are still molten are displaced with the aid of a fluid. Depending on the application, the fluid used can be gas or water. With projectile injection technology, a fluid-driven projectile is used.

With the fluid pressure applied internally, the warpage of the component can be reduced. Shorter cycle times resulting from the greater dissipation of heat and the avoidance of any accumulation of melt are also possible. Other advantages are greater freedom of design and the opportunity to create components with high specific rigidity.

At present, the products used are primarily reinforced Ultramid® grades. Some Ultramid® grades are optimized for FIT; for example the hydrolysis-resistant Ultramid® A3HG6 WIT is particularly suitable for cooling-water lines, while other grades, e.g. Ultramid® B3WG6 GIT, allow particularly good surface qualities.

Overmolding of inserts

Particularly for applications in the automotive sector, it is very important to be able to produce lightweight, high-strength plastic components. The combination of thermoplastic laminates and tapes with Ultramid® offers opportunities for innovative solutions here. Laminates can be inserted heated into the injection mold, reshaped and then overmolded with Ultramid®. Suitable Ultramid® grades fitted to each other are available for this purpose. The draping of the laminates in the cavity as well as the overmolding process and the resulting mechanical component properties can be analyzed using Ultrasim®.

Metal parts can also be overmolded with Ultramid®. However, if they are of a fairly large size, they should be preheated to 100°C to 150°C, but at least to the mold temperature, so that no excessive internal stresses occur in the molding. The metal parts must be clean of any grease and if necessary have knurlings, circumferential grooves or similar features for better anchoring.

Thermoplastic foam injection molding (TFIM)

The addition of chemical or physical blowing agents causes the melt to expand during the filling of the mold. So sink marks can be avoided even with large wall thicknesses. If necessary, it also allows the weight of the component to be reduced. In addition, the fill pressure is considerably reduced so that a machine with a lower closing force can be used. However, it should be noted that the mechanical and the surface properties can be influenced in a negative way depending on the level of expansion. Ultramid® B3WG6 SF is particularly suited to the TFIM process.

Machining

Semi-finished parts made from Ultramid® can be machined and cut using all the usual machine tools. General rules which apply are that cutting speed should be high while the rate of advancement is low and care should be taken that tools are sharp.



Coolant water pipe

Joining methods

Parts made from Ultramid® can be joined at low cost by a variety of methods. They can be easily joined using special screws suitable for plastics which form their own threads (self-tapping screws). Ultramid® parts can be connected without difficulty to one another or to parts made from other materials by means of rivets and bolts.

Metal inserts have proved to be effective for screw connections subjected to high stresses. These are overmolded or attached subsequently in prepared holes by means of ultrasound or hot embedding.

Snap-in and press-fit connections can also withstand high stresses. Ultramid®'s outstanding elasticity and strength, even at high temperatures, are particularly advantageous for this form of construction.

Practically all methods developed for welding thermoplastics are suitable for Ultramid®. The following welding methods are employed for moldings:

- Vibration welding (linear, biaxial)
- Spin welding
- Ultrasonic welding
- Laser beam welding
- Infrared welding
- Hot gas welding

All these methods have their own specific advantages and disadvantages (Table 9). As a rule they require special joint geometries and configurations adapted to the welding technique so that the welding method should be chosen before the final design is drawn up.

Directions for design and choice of welding parameters can be found in the corresponding guidelines of the DVS (Deutscher Verband für Schweißtechnik, Düsseldorf = German association for welding technology).

Heat impulse welding, and high-frequency welding in the case of suitable formulations, are preferably used for film. However, laser-beam, heating-element and ultrasonic welding may also be used.

Adhesive solvents or varnishes are particularly suitable for bonding Ultramid®. These may be based for example on phenol or resorcinol solutions, concentrated formic acid, solid adhesives with or without chemical crosslinking (reactive or two-component adhesives), on polymerizable, pressure-sensitive and contact adhesives.

Parts made from Ultramid® grades can be bonded securely to rubber, e.g. after surface treatment.

Method	Advantages	Disadvantages	Applications
Vibration	relatively short cycle times; high strength	high welding pressure; stress caused by vibration; grainy weld flash; wide seam	air intake manifolds, containers, air ducts
Rotation	relatively short cycle times; high strength	rotation-symmetrical seam necessary	containers, connection pieces, covers, linear sections, filter housings
Ultrasound	short cycle times; possibility of integration into production lines	high mechanical stress due to vibrations; possible damage due to covibration	housings, devices, bearing cages, filters
Laser	flash-free, clean welding seam; stress-free welding; design freedom	material adaptation conceivably necessary	housings, covers, filters, medical devices
Heating element Heat contact	high strength; smooth, contiguous flash	long cycle time; adhesion of the melt to the heating element; process possible, if the heating element is cleaned	containers
Heating element radiation	high strength; smooth, contiguous flash	long cycle time; only minor warpage permissible or else compensation by mold necessary	housings

Table 9: Advantages and disadvantages of welding methods

Printing, embossing, laser marking, surface coating, metallizing

Printing

Printing on Ultramid® using conventional paper-printing methods requires no pretreatment. Injection-molded parts should be largely free of internal stresses and produced as far as possible without mold release agents, particularly those containing silicone. Special tried and tested inks are available for printing to Ultramid®.

Hot embossing

Ultramid® can be hot-embossed without difficulty using suitable embossing foils.

Laser marking

Marking Ultramid® using lasers affords a series of advantages with respect to conventional methods, particularly when there are tough requirements for permanence, flexibility and speed.

The following information is intended only to provide initial guidance. The Ultra-Infopoint will be happy to give more detailed advice, on the choice of Ultramid® colors that are best suited to laser marking.

Nd-YAG lasers (wavelength 1064 nm)

Uncolored standard Ultramid® grades are practically impossible to mark with Nd-YAG lasers due to very low absorption of energy. This also applies to glass-fiber reinforced and mineral-filled grades. Better markability for Ultramid® grades can be achieved by using special additives. High-contrast lettering is obtained with certain black pigmentations.

Uncolored Ultramid® A3X grades can be marked with good contrast but not in customary black colors.

The Ultramid® LS range comprising unreinforced, reinforced and flameproofed grades was specially developed for marking using the Nd-YAG laser. The Ultra-Infopoint will be happy to send you an overview on request.

Nd-YAG lasers (wavelength 532 nm)

A frequency-doubled Nd-YAG laser can generally produce higher definition and higher contrast images on uncolored and brightly colored Ultramid® grades than a Nd-YAG laser (1064 nm). There is no advantage in the case of black colors.

Excimer lasers (wavelength 175-483 nm)

Excimer lasers produce a higher definition and a better surface finish on Ultramid® than do Nd-YAG devices. Good results are achieved especially for bright colors.

CO₂ lasers (wavelength 10640 nm)

Uncolored and colored Ultramid® is practically impossible to mark with CO₂ lasers. At best there is only barely perceptible engraving of the surface without color change.

Surface coating

Due to its outstanding resistance to most solvents Ultramid® can be coated in one or more layers with various paints which adhere well and have no adverse effects on mechanical properties. One- or two-component paints with binders matched to the substrate are suitable. Waterborne paints and primers can also be applied to Ultramid®. A mixture of isopropanol and water or other specific cleaning agents can be used for preliminary treatment. Industrial processes, such as preliminary treatment in automotive paint shops, are also suitable for cleaning. Coating based on electrostatics is only possible with what is known as a conductive primer as Ultramid® is not sufficiently conductive in its own right.

Metallizing

After proper pre-treatment, parts made of Ultramid® can be metallized galvanically or in a high vacuum. With unreinforced as well as reinforced materials a flawless surface is achievable. Metallized parts made of Ultramid® are increasingly used in the sanitary, the electronics and automotive industries.

Conditioning

Ultramid® parts, especially those made from standard injection molding grades, only achieve their optimum impact strength and constant dimensions after absorption of moisture. Conditioning, i.e. immersion in warm water or storage in warm, moist air is used for the rapid attainment of a moisture content of 1.5 to 3%, the equilibrium content in normal moist air (Fig. 16 and individual values in the Ultramid® product range).

Practical conditioning method

Immersion in warm water at 40 °C to 90 °C is simple to carry out but it can result in water stains, deposits and, especially in the case of thin parts with internal stresses, in warpage. Additionally, in the case of the reinforced grades the quality of the surface can be impaired. Furthermore, conditioning of A3X grades in a waterbath at higher temperatures is not recommended.

Accordingly, preference is generally given to the milder method of conditioning in humid air (e.g. at 40 °C and 90 % relative humidity or in 70/62 conditions for the accelerated conditioning of test specimens in accordance with ISO 1110). Here too the temperature should not exceed about 40 °C for parts made from Ultramid® A3X.

Duration of conditioning

The time required for conditioning to the normal moisture content (standard conditions 23/50) increases with the square of the wall thickness of the parts but decreases markedly with rising temperature. Table 10 gives the conditioning times needed for flat parts (sheet) made from Ultramid® A and B grades as a function of wall thickness and conditioning conditions in either a moist atmosphere or in a waterbath. Conditioning in a moist atmosphere, e.g. 40 °C/90 % r.h., is generally recommended as a mild thermal treatment.

The technical information “Conditioning Ultramid® moldings” provides further details.

Annealing

Annealing, e.g. by heat treatment for 12 to 24 hours (in air or in an annealing liquid at 140 °C to 170 °C) can largely remove internal stresses occurring in thick-walled parts made from grades with a high modulus of elasticity (e.g. Ultramid® A3EG7) or in extruded semi-finished parts. Annealing also results in postcrystallization of incompletely crystallized injection-molded parts (produced with a cold mold). On the one hand this causes an increase in density, abrasion resistance, rigidity and hardness and on the other hand it gives rise to slight after-shrinkage and sometimes a small amount of warpage.

Ultramid®	Equilibrium moisture content atmosphere HSC 23/50 [%] ¹⁾	Conditions	Thickness [mm]						
			1	2	4	6	8	10	
A grades unreinforced glass-fiber reinforced mineral-filled	2.8	Water bath	40 °C	6	31	110	240	480	670
			60 °C	1.5	6	24	60	120	190
			80 °C	0.5	2	8	20	36	60
	1.2...2.2 1.4...1.5	Atmosphere	40 °C/90%	24	96	430	960	1700	2900
			70 °C/62% ²⁾	15	60	240	550		
B grades unreinforced glass-fiber reinforced mineral-filled	3.0	Water bath	40 °C	3.5	14	60	120	240	380
			60 °C	1	4	16	36	72	110
			80 °C	0.5	1	4	10	18	24
	1.5...2.6 2.0...2.4	Atmosphere	40 °C/90%	15	60	260	600	1100	1700
			70 °C/62% ²⁾	10	48	120	240		

Table 10: Time in hours required for Ultramid® sheet to attain a moisture content corresponding to the equilibrium moisture content obtained in a standard atmosphere (23 °C/50%)¹⁾ at storage of Ultramid® sheet in hot waterbath or in moist climate

¹⁾ Values for individual grades in SC 23/50 are given in the Ultramid® product range

²⁾ Used in ISO 1110-Polyamides-Accelerated conditioning of test specimens in SC 23/50

General information

Safety notes

Safety precautions during processing

As far as the processing is done under recommended conditions (see the product-specific processing data sheets), Ultramid® melts are thermally stable and do not give rise to hazards due to molecular degradation or the evolution of gases and vapors. Like all thermoplastic polymers, Ultramid® decomposes on exposure to excessive thermal load, e.g. when it is overheated or as a result of cleaning by burning off. In such cases gaseous decomposition products are formed. Further information can be found in the product-specific data sheets.

When Ultramid® is properly processed no harmful vapors are produced in the area of the processing machinery.

In the event of incorrect processing, e.g. high thermal stresses and/or long residence times in the processing machine, there is the risk of elimination of pungent-smelling vapors which can be a hazard to health. Such a failure additionally becomes apparent due to brownish burn marks on the moldings. This is remedied by ejection of the machine contents into the open air and reducing the cylinder temperature at the same time. Rapid cooling of the damaged material, e.g. in a waterbath, reduces nuisances caused by odors.

In general measures should be taken to ensure ventilation and venting of the work area, preferably by means of an extraction hood over the cylinder unit.

Food regulations for Ultramid®

The grades in the Ultramid® range marked FC comply with the current legislation on plastics in contact with food in Europe and the USA. In addition, the conformity of these products is guaranteed by manufacturing in accordance with the GMP (Good Manufacturing Practice) standard. If detailed information about the food approval status of a particular Ultramid® grade is required, please contact BASF directly (plastics.safety@basf.com). BASF will be happy to provide an up-to-date declaration of conformity based on the current legal regulations.

Available under the name FC Aqua® are Ultramid® grades which, in addition to being used in components in contact with food, also have different country-specific approvals for applications involving contact with drinking water. All plastics in the Aqua® range have the approvals in line with KTW¹⁾, DVGW²⁾, and WRAS³⁾ in cold-water applications, and a large proportion of them for warm and hot water, too. In order to make it easier for the finished components to be approved, BASF provides all the certificates required for Germany and Great Britain. If approvals from the ACS⁴⁾, the 5NSF⁵⁾ or other institutes are required, BASF assists by disclosing the formulation to the institutes. For questions regarding compliance with further regulations and certificates, please contact your local BASF representative or Plastics Safety (e-mail: plastics.safety@basf.com, fax: +49 621-60-93253).

¹⁾ KTW: Kontakt mit Trinkwasser (Germany)

²⁾ DVGW: Deutscher Verein des Gas- und Wasserfachs (Germany)

³⁾ WRAS: Water Regulation Advisory Scheme (UK)

⁴⁾ ACS: Attestation de Conformite Sanitaire (France)

⁵⁾ NSF: National Sanitation Foundation (USA)

Quality and environmental management

Quality and environmental management are an integral part of BASF's corporate policy. One key objective is to ensure customer satisfaction. A priority is to continuously improve our products and services with regard to quality, environmental friendliness, safety, and health. The business unit Engineering Plastics Europe has a quality and environmental management system, which was approved by the German Society for Certification of Management Systems (DQS):

- Quality management system in accordance with ISO 9001 and ISO/TS 16949
- Environmental management system in accordance with ISO 14001

The certification covers all services by the business unit in terms of the development, production, marketing, and distribution of engineering plastics. In-house and external audits and training programs for employees are conducted on a regular basis to ensure the reliable functionality and continuous development of the management systems.

Quality assurance

Goods inward inspection at the converter

In most countries converters have a legal duty to carry out goods inward inspections. Such inspections are also essential because it is only in this way that the converter can obtain reliable knowledge as to the state of the goods at the time of their arrival.

Apart from a visual examination, depending on the product and requirements a goods inward inspection for Ultramid® primarily covers the set of test methods set out in Table 11. Many other test methods suitable for Ultramid® are presented in ISO 1874-2 "Polyamide molding compounds for injection molding and extrusion – Part 2".

The values obtained from these test methods for the various Ultramid® grades are given in the Ultramid® product range.

Test method ¹⁾	Typical value given in Ultramid® range chart	Test standards	Remarks
Identification		DIN 53746	Simple methods of identification by means of melting point, density, solubility
Melting point	•	ISO 11357	Plastics – Differential scanning calorimetry (DSC)
Density	•	ISO 1183	BASF simplified density titration method
Ash	• ²⁾	ISO 3451-4	To determine the content of reinforcing material
Viscosity number VZ	•	ISO 307	Solvent 96% H ₂ SO ₄ , in the case of reinforced and modified products, a correction must be made to the amount weighed out
Melt volume rate MVR	•	ISO 1133	Preferred test conditions: 275 °C/5 kg load (Ultramid® T 325 °C/5 kg); material must contain less than 0.05% water
Moisture content	• ³⁾	ISO 15512	Coulometric Karl-Fischer-Titration

Table 11: Test methods for goods inward inspection of Ultramid®

¹⁾ All tests can be performed on the molding compound or on the molded part.

²⁾ Nominal values for the amount reinforcing material are given in the product range.

³⁾ Ultramid® is supplied ready for processing with moisture content of less than 0.15% (injection molding) or 0.1% (extrusion).

Quality assurance in the converting plant

Quality assurance is a component of every modern injection molding operation because apart from effects arising from the product the quality of Ultramid® moldings is primarily determined by the processing parameters. Unchanging processing conditions are the prerequisite for obtaining injection-molded parts of consistent quality. The most important process parameters are:

- Melt temperature
- Mold filling speed
- Holding pressure and time
- Mold surface temperature

Modern injection molding machines are fitted with process regulation instruments with which the defined variables can be kept constant within a narrow tolerance range. Narrower process tolerances during processing generally give rise to injection-molded parts having a uniform quality. Quality assurance can be facilitated through documentation of the actual values.

Important quality criteria for Ultramid® moldings are:

- Dimensional stability (freedom from warpage)
- Surface finish

A simple test on finished parts is to weigh them. Any inconsistency in a process can generally be observed through weight fluctuations. Surface finish is checked by visual examination.

Examples of typical surface faults include discoloration, flow lines, streaks, marks, grooves, sink marks, glass-fiber effects and warps.

A light-microscopic image showing the structure of thin layers of injection-molded parts is an important quality criterion, especially in the case of the non-reinforced grades. It serves to depict defective crystalline structures and other irregularities inside the parts. Consequently, the quality of Ultramid® molded parts can be assessed so that conceivable causes for flaws can be ascertained.

Examination of the microstructure is also useful for determining the optimum processing conditions. It can also form part of continuous quality assurance procedures.

Planned quality control tasks while production is in progress are essential for obtaining high-quality engineering parts from Ultramid®. They can be carried out by means of sampling or if need be done on all parts. Computer assisted test devices reduce the workload for measurements and facilitate documentation of the tests.

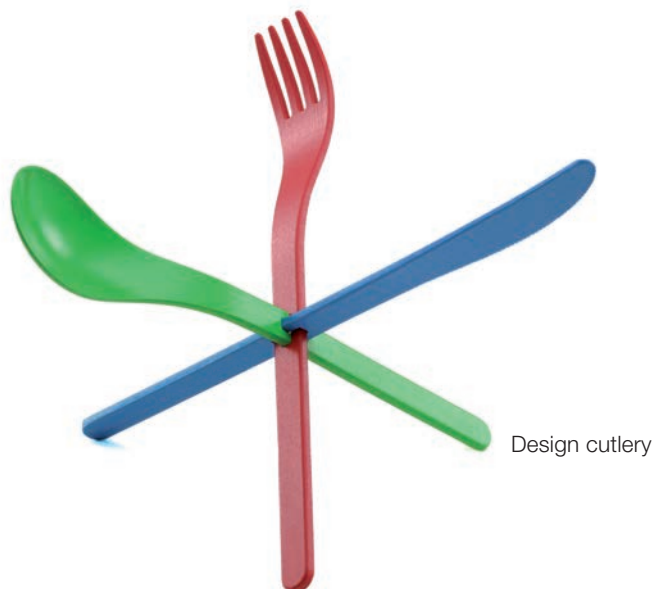

Delivery and storage

Ultramid® is supplied in the form of cylindrical or lenticular granules. The bulk density is approximately 0.7 g/cm³. The products are dried so as to be ready for processing and they are delivered in moisture-tight packaging. The standard types of packaging are 25-kg special bags and 1000-kg bulk-product containers (octagon IBC = intermediate bulk container made of corrugated cardboard with a liner bag). Upon consultation, other kinds of packaging and shipment in silo trucks or railway cars are likewise possible. All packaging is tightly sealed and should only be opened immediately prior to the processing. The material, which is delivered completely dry, should not be permitted to absorb any moisture from the air, so that all packaging has to be stored in dry rooms and must always be carefully sealed again after any portions have been removed.

When Ultramid® is kept in undamaged packaging bags, it can be stored indefinitely. Experience has shown that the product delivered in an IBC can be stored for approximately three months without the processing properties being impaired by moisture absorption. Packaging stored in cold areas should be allowed to warm up to room temperature before being opened so that no condensation can precipitate onto the granules. Individual products differ in details of drying conditions and the optimum moisture at processing. These details can be found in the processing data sheets.

Colors

Ultramid® is supplied in both uncolored and colored forms. Uncolored Ultramid® has a natural opaque white color. Many products are available in black. Individual grades are available in several standard colors on request.

The H and W stabilized Ultramid® grades as well as Ultramid® A3X grades are exceptions which can only be supplied in black or natural because their natural color does not permit colored pigmentation to a specific shade.

Door handle



Ultramid® and the environment

Storage and transportation

Under normal conditions Ultramid® can be stored indefinitely. Even at elevated temperatures, e.g. 40 °C in air, and under the action of sunlight and weather no decomposition reactions occur (cf. sections “Delivery and storage” and “Behavior on exposure to weather”).

Ultramid® is not a hazardous material as defined by the CLP ordinance (EG) No.1272/2008 and hence is not a hazardous material for transportation (cf. Ultramid® safety data sheet).

Ultramid® is assigned as not posing any risk to water.

Waste disposal

Subject to local authority regulations Ultramid® can be incinerated. The calorific value of unreinforced grades amounts to 29000 to 32000 kJ/kg (Hu according to DIN 51900).

Recovery

Like other production wastes, sorted Ultramid® waste materials, e.g. ground up injection-molded parts and the like, can be fed back to a certain extent into processing depending on the grade and the demands placed on it. In order to produce defect-free injection-molded parts containing regenerated material the ground material must be clean and dry (drying is usually necessary). It is also essential that no thermal degradation has occurred in the preceding processing. The maximum permissible amount of regrind that can be added should be determined in trials. It depends on the grade of Ultramid®, the type of injection-molded part and on the requirements. The properties of the parts, e.g. impact and mechanical strength, and also processing behavior, such as flow properties, shrinkage and surface finish, can be markedly affected in some grades by even small amounts of reground material.



Adapter for gardening tools

Services

Ultrasim®

Ultrasim® is BASF's comprehensive and flexible CAE expertise with innovative BASF plastics. The modern calculation of thermoplastic components is very demanding for the developer. When it comes to the interaction between manufacturing process, component geometry and material, only an integrated approach can lead to an ideal component. Plastics reinforced with short glass fibers in particular have anisotropic properties depending on how the fibers perform in injection molding. Modern optimization methods support the component design and can improve it in every phase of its development.

BASF's Integrative Simulation incorporates the manufacturing process of the plastic component into the calculation of its mechanical performance. This is provided by a completely new numerical description of the material which takes the properties typical of the plastic into account in the mechanical analysis. These properties include

- anisotropy
- non-linearity
- dependence on strain rate
- tension-compression asymmetry
- failure performance
- dependence on temperature.

So, BASF is more than a raw material manufacturer supplying innovative plastics that meet delivery time and quality requirements. Ultrasim® adapts flexibly to meet individual customer requirements – for highly loadable efficient, lightweight parts and thus longterm market success.

Materials testing, parts testing and processing service

The accredited laboratory for molding compound or materials testing can advise and support customers on all aspects of materials science and plastics-specific tests (accreditation certificate D-PL-14121-04-00 in accordance with DIN EN ISO/IEC 17025:2005). The range of testing services available covers the full spectrum of mechanical, thermal and electrical properties, but also topics such as weathering or fire performance.

Another vital service is offered by the laboratory for parts testing and joining technology which supports customers' project work. The extensive test capabilities include:

- heat aging, temperature and climate storage tests
- temperature shock tests
- tensile, compression, bending, pull-out tests
- impact tests (crash, drop, head impact, stone impact)
- cyclic internal pressure tests with superimposed temperature and climate profiles
- flow tests, leak tests
- acoustic analyses
- deformation and strain measurements by means of stereo photogrammetry
- optical 3D digitizing of components
- documentation of all transient processes with high-speed cameras
- testing, evaluation and optimization of all relevant joining technologies
- laser transparency and laser markability analyses

An experienced team of processing experts is available to answer questions about processing, processing technology as well as special processing techniques. A well-equipped technical processing center can be used for project work. There the processing of high temperature thermoplasts, multicomponent injection molding, GIT and WIT as well as the overmolding of thermoplastic composites is possible.



Torque rod support

Nomenclature

Structure

The name of Ultramid® commercial products generally follows the scheme below:

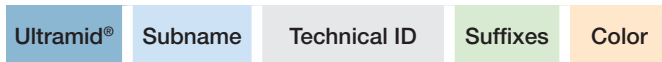

Subnames

Subnames are optionally used in order to particularly emphasize a product feature that is characteristic of part of a range.

Examples of subnames:

Endure	Particularly good long-term stabilization against hot air
Structure	Particularly good notched impact strength at low temperatures, and without any disadvantages for the stiffness and strength

Technical ID

The technical ID is made up of a series of letters and numbers which give hints about the polymer type, the melt viscosity, the stabilization, modification or special additives and the content of reinforcing agents, fillers or modifiers. The following classification scheme is found with most products:

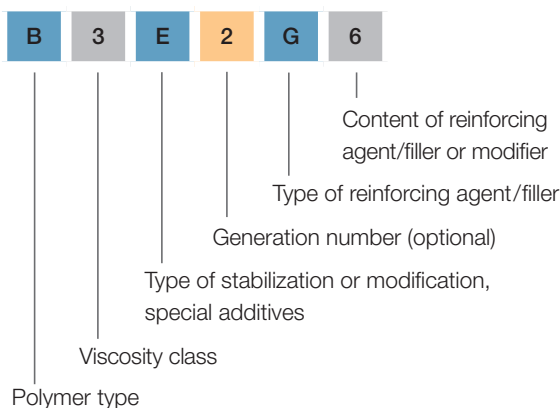

Ultramid® T generally has the following classification scheme:

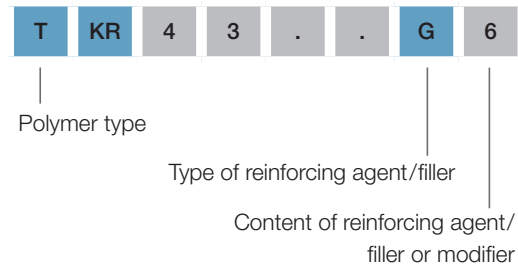

Letters for identifying polymer types

A	Polyamide 66
B	Polyamide 6
C	Copolyamide 66/6
D	Special polymer
S	Polyamide 610
T	Polyamide 6T/6

Numbers for identifying viscosity classes

3	Free-flowing, low melt viscosity, mainly for injection molding
35	Low to medium viscosity
4	Medium viscosity

Letters for identifying stabilization

E, K	Stabilized, light natural color, enhanced resistance to heat aging, weather and hot water, electrical properties remain unaffected
H	Stabilized, enhanced resistance to heat aging, hot water and weather, only for engineering parts, electrical properties remain unaffected, depending on the grade light-beige to brown natural color
W	Stabilized, high resistance to heat aging, can only be supplied uncolored and in black, less suitable if high demands are made on the electrical properties of the parts

Letters for identifying special additives

F	Functional additive
L	Impact-modified and stabilized, impact resistant when dry, easy flowing, for rapid processing
S	For rapid processing, very fine crystalline structure, for injection molding
U	With flame-retardant finish without red phosphorus
X	With red phosphorus as the flame-retardant finish
Z	Impact-modified and stabilized with very high low-temperature impact strength (unreinforced grades) or enhanced impact strength (reinforced grades)

Letters for identifying reinforcing agents/fillers

C	Carbon fibers
G	Glass fibers
K	Glass beads
M	Minerals
GM	Glass fibers in combination with minerals
GK	Glass fibers in combination with glass beads

Key numbers for describing the content of reinforcing agents/fillers or modifiers

2	approx. 10 % by mass
3	approx. 15 % by mass
4	approx. 20 % by mass
5	approx. 25 % by mass
6	approx. 30 % by mass
7	approx. 35 % by mass
8	approx. 40 % by mass
10	approx. 50 % by mass

In the case of combinations of glass fibers with minerals or glass beads, the respective contents are indicated by two numbers, e. g.

GM53	approx. 25 % by mass of glass fibers and approx. 15 % by mass of minerals
GK24	approx. 10 % by mass of glass fibers and approx. 20 % by mass of glass beads

M602 represents approx. 30% by mass of a special silicate (increased stiffness).

Suffixes

Suffixes are optionally used in order to indicate specific processing or application-related properties. They are frequently acronyms whose letters are derived from the English term.

Examples of suffixes:

Aqua®	Meets specific regulatory requirements for drinking water applications
Balance	Based at least partly on renewable raw materials
CR	Crash Resistant
EQ	Electronic Quality
FC	Food Contact; meets specific regulatory requirements for applications in contact with food
GIT	Gas Injection Technology
GP	General Purpose
High Speed	High flowability of the melt
HP	High Productivity
HR	Hydrolysis Resistant, increased hydrolysis resistance
HRX	New generation of HR products
LDS	Laser Direct Structuring, for preparing the electroplating of electrical conductor tracks
LF	Long Fiber Reinforced
LS	Laser Sensitive, can be marked with Nd:YAG laser
LT	Laser Transparent, can be penetrated well with Nd:YAG lasers and lasers of a similar wavelength
SF	Structural Foaming
SI	Surface Improved, for parts with improved surface quality
ST	Super Tough
WIT	Water Injection Technology

Color

The color is generally made up of a color name and a color number.

Examples of color names:

Uncolored
Black 00464
Black 00564
Black 20560

Subject index

- Adapter for gardening tools 60
- Aftershrinkage 49 ff.
- Air module 5
- Annealing 55
- Automotive engineering 4 f.
- Ax handle 9

- Behavior on**
 - exposure to weather 36 ff.
 - heat 22
- Behavior under
 - cyclic loads, flexural fatigue strength 21
 - long-term static loading 20
- Brush holder 26

- Circuit breaker** 6, 22
- Circuit carrier 37
- CO₂ lasers 54
- Colors 59
- Conditioning 55
- Connector 14
- Construction and installation engineering 8
- Consumer goods 8
- Cooking set 9
- Coolant water pipe 52

- Delivery** 59
- Design chairs 8, 10
- Design cutlery 58
- Dimensional stability 24 f.
- Domestic appliances 6
- Door handle 59
- Dowels 9, 24
- Drying 42
- Duration of conditioning 55

- Electrical properties** 26 f.
- Electrical and electronics sector 6 f.
- Embossing 54
- Environment 60
- Environmental management 57

- Electronics** 6
 - Examples of typical applications in automotive engineering 4, 5
 - Examples of typical applications in the electrical and electronics sector 6, 7
 - Examples of typical applications in the industrial sector 8, 9
- Excimer lasers 54
- Exterior mirror base 44

- Fire behavior** 28 f.
 - Fixing brake 5
 - Fixing clip for photovoltaic modules 36
- Flow behavior 48
- Fluid injection technology (FIT) 52
- Food regulations 56
- Fuel pressure sensor 38

- Gearbox control** 27
- General mechanical and instrument engineering 8
- Generator end cap 29
- Glass-fiber reinforced Ultramid® 11
- Goods inward inspection at the converter 57

- Heat aging resistance** 23
- Heat aging resistance in
 - coolants 24
 - hot lubricants 24
 - solvents 24
- Heat shield 5
- High-voltage connector 6
- Holding pressure 48
- Hood switch 43
- Hot embossing 54

- Impact strength** 19 f.
- Injection mold 44 f.
- Injection molding 46 ff.
- Industrial products 8 f.
- Injection rate 48
- Intake manifold 5

- Joining methods** 53

- Laser marking 54
Loudspeaker grills 4
Low-temperature impact strength 19 f.
- M**achine and technique for injection molding 43 ff.
Machining 52
Materials handling technology 8
Materials testing 61
Mechanical properties 16 ff.
Melt temperature 46
Melt viscosity 41
Melting behavior 40
Metallizing 54
Microswitch 7
Mineral-filled Ultramid® 11
Mold temperatures 47
Mounting for flat-roof photovoltaic systems 40
Multi-component technology 52
- Nd:YAG** lasers 54
Nomenclature 62 f.
- O**ffice chairs 9
Office lamp 34
Oil filter module 35
Oil pan 5, 31
Oil sensor 31
Oil suction module 5
Overmolding of Inserts 52
- P**arts testing 61
Pedal block 4
Photovoltaics 6
Photovoltaic box 7
Plasticizing unit 43 f.
Power technology 6
Practical conditioning method 55
Preliminary treatment 42
Printing 54
Processing 40 ff.
Processing characteristics 40 f.
Processing service 61
Product Range 10 ff.
Properties 10 ff.
- Q**uality assurance 57 f.
Quality assurance in the converting plant 58
Quality management 57
Quick connector 39
- R**ecovery 60
Recycling of ground material 42
Reinforced grades with flame retardants 11
Reprocessing 42
Resistance to chemicals 30 ff.
- S**afety notes 56
Safety precautions during processing 56
Sanitary technology 8
Screw speed 47
Self-coloring 42
Sensor 7
Services 61
Setting behavior 40
Shrinkage 49 ff.
Ski binding 9
Snap-in and press-fit 53
Special methods 52
Storage 59, 60
Surface coating 54
- T**erminal carrier 29
Terminal strip 7
Tests
– Construction industry 29
– Electrical engineering 28
– Transportation 29
Thermal dowel 45
Thermal properties 22 ff.
Thermal properties 41
Thermoplastic foam injection molding (TFIM) 52
Thermostability of the melts 41
Thermostat housing 30
Torque rod support 61
Transmission cross beam 51
Tribological behavior 21

Ultramid® A 11
Ultramid® B 11
Ultramid® C 11
Ultramid® D 11
Ultramid® S Balance 11
– Chemical and hydrolysis resistance 39
– Mechanical properties 39
Ultramid® T 11
– Chemical resistance 38
– Mechanical properties 37 f.
– Shrinkage and warpage 38
Ultrasim® 61
Unreinforced grades with flame retardants 11

Warpage 51
Waste disposal 60
Water absorption 24 f.
Welding 53

Selected Product Literature for Ultramid®:

- Ultramid® – Product Range
- Ultramid® Structure – Recommended by Leading Testers
- Ultramid® Endure – Polyamide Speciality for Injection Molding and Blow Molding
- Ultramid® B High Speed – Polyamide 6 with Improved Flow Properties
- Ultramid® 1C – A Clear Case for Coatings
- Conditioning Ultramid® Moldings – Technical Information
- Ultramid®, Ultradur® and Ultraform® – Resistance to Chemicals
- Ultramid® and Ultradur® – Engineering Plastics for Photovoltaic Mounting Systems
- From the Idea to Production – The Aqua® Plastics Portfolio for the Sanitary and Water Industries
- Engineering Plastics for the E/E Industry – Standards and Ratings
- Engineering Plastics for the E/E Industry – Products, Applications, Typical Values
- Engineering Plastics for Automotive Electrics – Products, Applications, Typical Values

Note

The data contained in this publication are based on our current knowledge and experience. In view of the many factors that may affect processing and application of our product, these data do not relieve processors from carrying out own investigations and tests; neither do these data imply any guarantee of certain properties, nor the suitability of the product for a specific purpose. Any descriptions, drawings, photographs, data, proportions, weights etc. given herein may change without prior information and do not constitute the agreed contractual quality of the product. It is the responsibility of the recipient of our products to ensure that any proprietary rights and existing laws and legislation are observed. (August 2013)

Please visit our websites:

www.plasticsportal.com (World)

www.plasticsportal.eu (Europe)

Additional information on specific products:

[www.plasticsportal.eu/name of product](http://www.plasticsportal.eu/name_of_product)

e. g. www.plasticsportal.eu/ultramid

Request of brochures:

PM/K, F 204

Fax: +49 621 60-49497

If you have technical questions on the products,
please contact the Ultra-Infopoint:

